

BREAKING NEWS



Q2 2026

AWIMEX
YOUR NEED – OUR SOLUTION

strands[®]
-lighting division

STAY UPDATED

Subscribe to our newsletter to stay updated on Strands' latest product releases. Once a week you'll receive in-depth guides on vehicle lighting, special announcements, and essential information about exciting new products.



Subscribe to our newsletter to receive the latest news on vehicle lighting



READ STRANDS CATALOGS ONLINE

Did you know you can read this and all of our catalogs online? Scan the QR code to access previous Breaking News catalogs, as well as catalogs for model-adapted warning lights, agricultural vehicles, off-highway, trucks, product series, and more. If you're looking for inspiration for your next lighting project, this is the place to start.



Check out the catalogs here

JOIN THE STRANDS COMMUNITY

Wearing Strands signals that you live what you drive. Each piece connects you to a community of builders, installers, and drivers driven by passion who value function and design. It's a promise to stay true to your standards, to refine the details, and to carry that passion from the workshop to the open road. hi-vis gear, everyday clothing, and accessories, Strands gear have you covered.



Check out Strands Gear



FUNCTION WARRANTY THREE TO SIX YEARS

More than design, quality, and performance, we offer peace of mind. All products in the Strands Lighting Division range are covered by a unique function warranty, valid for 3 to 6 years. The warranty is unique on the market and covers faults related to manufacturing, materials, and assembly. Our goal is to improve service, increase customer satisfaction, and emphasize our brand's quality.

▶ YOUTUBE



TRUCK TOUR

Meeting different drivers and seeing all the passion that goes into creating each unique truck is a huge inspiration and pure joy. Every fair means an opportunity to see the multitude of ways you use Strands' products. If you're curious about some of the trucks and drivers we've met during different fairs over the years, take a look at the Truck Tour playlist. In each episode, we get to listen to a driver guiding us through the look and products of their truck.



Follow us on YouTube

STRANDS LIGHT TEST LAB

At Strands HQ, we have an advanced lighting laboratory where we test all our products before releasing them to the market. We measure output, beam pattern, and performance so you can be sure your new light lives up to your expectations. When you see the graphic illustration of the output in our catalogs, it accurately reflects how the light performs in real life.



📷 INSTAGRAM

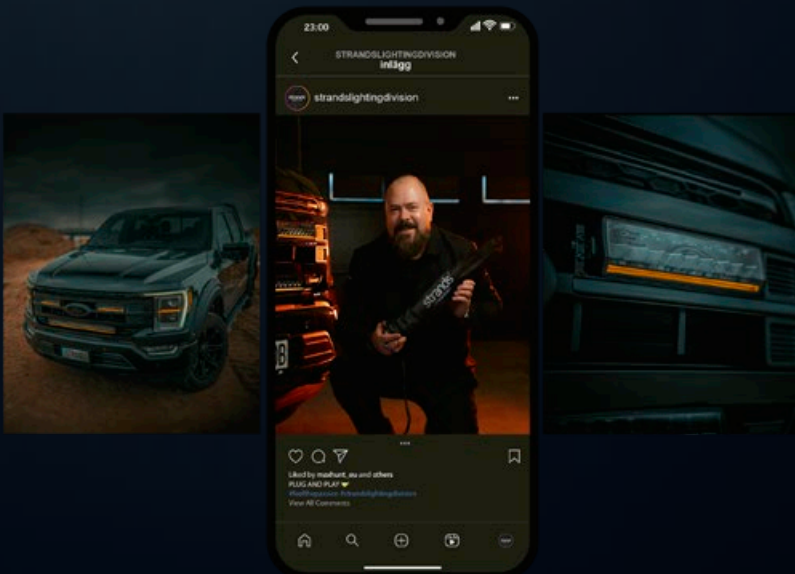

INSTAGRAM

Follow us on Instagram to participate in competitions, see our collaborations and follower content, and be the first to learn about exciting new product releases. We love to see all the creative ways you use your Strands products in action, so tag us @strandslightingdivision to be featured in our highlights section.



Follow us on Instagram

SIBERIA X

WORK LIGHT 4"

Part No. ST-270978

- ✓ 70W
- ✓ 1 LUX @ 102 METERS
- ✓ HELLO FUNCTION
- ✓ 5600 ACTUAL LUMEN



HELLO FUNCTION

Its modern design features an X-shaped dual-color position light in white and amber, which also glows through the back of the housing, creating a striking effect from any angle. The Hello function, exclusive to the Siberia XP series, allows signaling with the position lights.

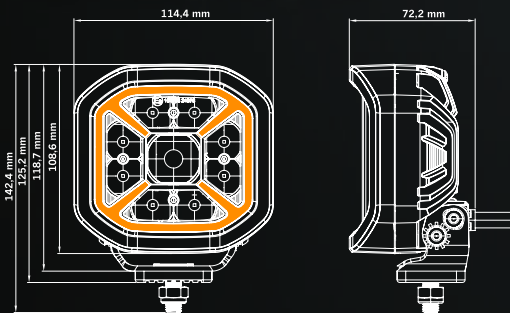

DT-4 CONNECTOR



Use the QR code to check out the products.

DURABLE AND VIBRATION-RESISTANT

Siberia X is built for demanding use. All components are tested for durability, from the internal electronics to the aluminum housing. The lamp is resistant to impacts and vibrations. The powder-coated surface protects against dirt, salt, water, and harsh conditions. Rated IP68/IP69K. The package includes bracket, screws, bolts, and rubber pad.

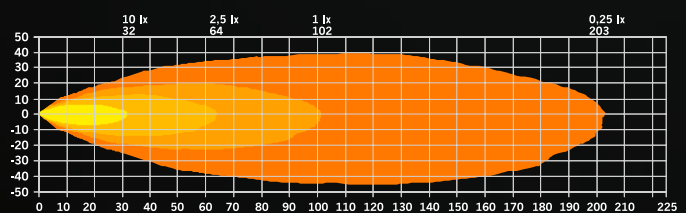

SIBERIA X

DRIVING LIGHT 4"

Part No. ST-270971 (4"), ST-270960 (7"), ST-270961 (9")

- ✓ THREE LENS COVERS
- ✓ HELLO FUNCTION
- ✓ UP TO 13 350 ACTUAL LUMENS

SIBERIA X 9"
Part No. ST-270961

SIBERIA X 7"
Part No. ST-270960

SIBERIA X 4"
Part No. ST-270971

XPERIENCE AND E-MODE

Xperience mode delivers extreme performance, with the Siberia X Driving Light producing up to 13 350 actual lumens and a beam range exceeding 800 meters. With a color temperature of 5700 K, the light is clear, crisp, and bright.

DT-4 CONNECTOR ON ALL SIZES

THREE LENS COVERS

Interchangeable lens covers for quick adjustment of light output and color temperature. Tool-free click-on design.

CLEAR FLOOD LENS COVER

Increases lateral (side) light distribution.
ST-270972 (4"), ST-270963 (7"), ST-270965 (9")

YELLOW FLOOD LENS COVER

Increases lateral light distribution and reduces glare. Suitable for rain, snow, and fog.
ST-270973 (4"), ST-270964 (7"), ST-270966 (9")

BLACK LENS COVER

Protects the lens. X-shaped position light remains visible.
ST-270974 (4"), ST-270958 (7"), ST-270959 (9")

Included in the package for Siberia X Driving light.

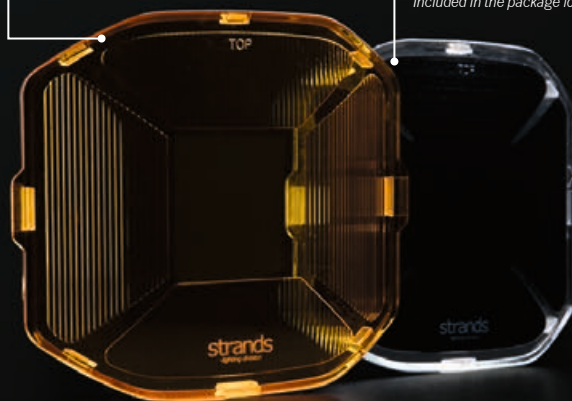
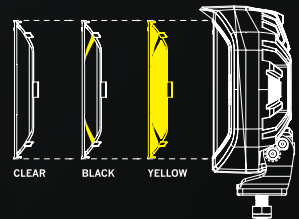

Use the QR code to check out the products.

TRUCK TOUR

STRANDS LIGHTING DIVISION

SIBERIA X 4"
DRIVING LIGHT
Part No. ST-270971

SIBERIA X 7"
DRIVING LIGHT
Part No. ST-270960

SIBERIA HI-LO
DRIVING LIGHT
Part No.
ST-270716 - ST-270717

SIBERIA X 4"
WORK LIGHT
Part No. ST-270978

AWIMEX
YOUR NEED - OUR SOLUTION

strands[®]
-lighting division

”

WHEN YOU'RE WORKING ON THE RAILWAY,
LONG-RANGE VISIBILITY IS ESSENTIAL.

ARVID PABY
ROAD-RAIL WHEEL LOADER OPERATOR



Scan the code to watch
the Truck Tour with Arvid

AWIMEX
YOUR NEED - OUR SOLUTION

strands[®]
-lighting division

BLACK RAVEN PHAROS

WARNING LIGHT BEACON

Part No. ST-905000 - ST-905000A

- ✓ LOW POWER CONSUMPTION
- ✓ TWO LENSES
- ✓ 12-24 DC



AMBER LENS
Part No. ST-905000A

INTERCHANGEABLE LENS

The dark lens is included, and the amber lens is available separately (Part No. ST-905000A). Thanks to the interchangeable lens, the Black Raven Pharos allows you to choose the ideal look for your vehicle. When you want to change the light pattern, it's easy to remove the lens and access the button.

BLACK RAVEN
PHAROS
Part No. ST-905000

SIMPLE TO INSTALL

This surface-mounted beacon is simple to install with a 2,5 m cable and a 117 mm diameter, with 108 mm CC measurements. Screws, washers, nuts, and an EVA pad are included in the package.

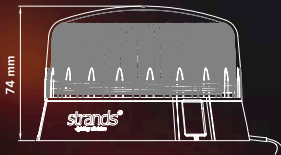

Use the QR code to
check out the products.

AWIMEX
YOUR NEED - OUR SOLUTION

strands[®]
-lighting division

IZE LED DOUBLE BURNER

POSITION LIGHT / WARNING LIGHT

Part No. ST-850458, ST-850458A, ST-850459

- ✓ UP TO 5,5 W
- ✓ DUO FUNCTIONS
- ✓ 10-32V DC
- ✓ THREE OPTIONS

SILVER ARROW
DOUBLE BURNER
Part No. ST-850458



CLEAR LENS

DUO COLOR AND WARNING LIGHT

The IZE LED double burner has a built-in warning light for extra visibility. The amber warning light has 21 light patterns to fit any situation. You can synchronize up to 12 double burners or Dark Knight Strobe lights for a complete look around your truck.

APPROVED AS SIDE MARKER
AND FRONT MARKER

BLACK BULLET
DOUBLE BURNER
Part No. ST-850459



DARK LENS

AMBER
DOUBLE BURNER
Part No. ST-850458A

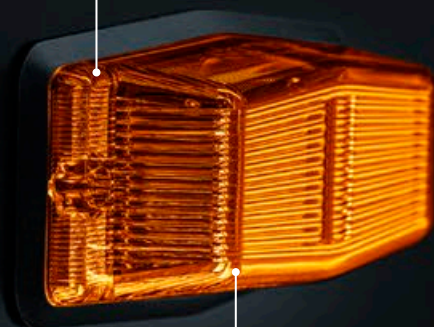

AMBER LENS

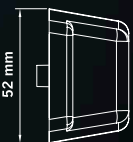
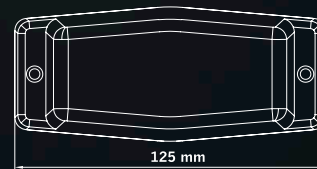

CORROSION-FREE

The housing is made of corrosion-resistant polycarbonate and rated IP69K. The IZE LED Double Burner is E-approved (R148) and EMC-certified (ECE R10). It measures 125 × 52 × 32 mm with 109 mm CC and is supplied with a 1000 mm cable.



Use the QR code to
check out the products

SKYLORD

LED BAR

Part No. ST-902000 - ST-902003

- ✓ BUILT-IN RELAY
- ✓ PLUG-AND-PLAY
- ✓ 1 LUX @ 1 KM
- ✓ 30 000 LUMEN

5-YEARS WARRANTY

This is the next generation of LED bars, with an output tailored to provide a new kind of lighting experience. The housing is cast in one piece, securing it against water, corrosion, vibrations, and dirt. Since the housing has no screw holes, it offers superior protection against wear and tear. It's waterproof, IP-rated IP69K, and has a new type of coating. It features double breathers and a solid build, making it especially suited to heavier vehicles. It's covered by Strands' unique 5-year warranty.



NO SCREW HOLES



AMBER AND WHITE
POSITION LIGHT

LED BAR

ONE LED BAR, 2X20 REFERENCE NUMBER

By combining clever design and innovative technology, we have integrated a dual light source into a single LED bar. This means that in the E-approved E-mode (R148/149), the 20"-40" Skylords have a reference number of 2x20. The 10" version has reference number 20. In many European countries, a dual light source is a requirement for road-legal lighting. This solution allows the Skylord LED bar to deliver more actual lumens while remaining approved in E-mode.

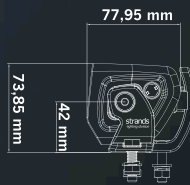
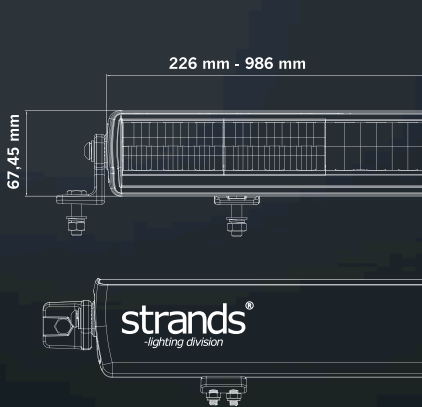

LED BAR 10"
Part No. ST-902000



LED BAR 20"
Part No. ST-902001



LED BAR 30"
Part No. ST-902002



LED BAR 40"
Part No. ST-902003



E-MODE 1 lx
281m - 781m



XPERIENCE MODE 1 lx
517m - 1090m

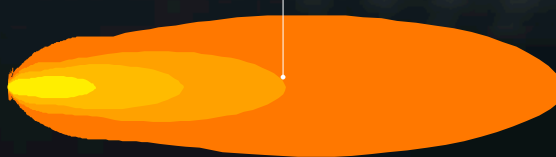

Use the QR code to check out the products.

1 LUX @ 1 KM

The new beam pattern provides maximum visibility to both the front and sides. It reaches further than the average combo beam and is broader and stronger closer to the vehicle than ordinary long-distance beams. All Skylord LED bars can be used with the E-approved E-mode or with Xperience mode. The Xperience mode is a powerful boost mode that reaches over 30,000 actual lumens and 1 lux @ 1 km for the 40" model.

HELLO FUNCTION

All Siberia LED bars over 20" have the eye-catching Hello function for the position lights. Just flash your high beam twice within two seconds, and the position lights activate their dynamic Hello to greet your fellow drivers.



30 000 LUMEN

AWIMEX
YOUR NEED - OUR SOLUTION

strands[®]
-lighting division

PASSION DRIVES

SKYLORD LED BAR

Part No. ST-902000 - ST-902003

EVOLUTION

30 000 LUMEN



CABLE HARNESS WITH SWITCH

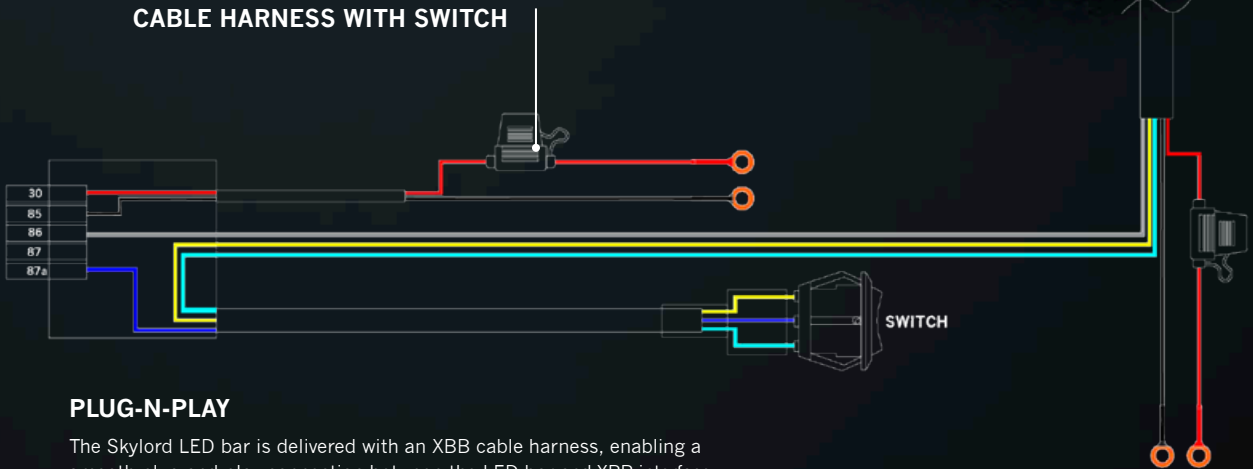

PLUG-N-PLAY

The Skylord LED bar is delivered with an XBB cable harness, enabling a smooth plug-and-play connection between the LED bar and XBB interface. The signal cable is already integrated into Output 1, and the position light into Output 2, ensuring fast and accurate setup. It features a pre-mounted switch for the position lights, located in the engine compartment, allowing you to easily switch them on or off with a simple press.

STRANDS PRO

CABLE HARNESS

Part No. ST-907001, ST-907003, ST-907006

- ✓ RELIABLE POWER DELIVERY
- ✓ BUILT FOR PERFORMANCE
- ✓ MADE FOR STRANDS LIGHTS
- ✓ 3-YEAR WARRANTY

DT-4 PIN TO 2X DT-4 PLUG SPLIT

Part No. ST-907001



Use the QR code to check out the product.

DT-SPLITTER

This cable has a DT-4 pin that splits into 2 DT-4 plugs. Input max is 150W, and split max consumption is 75W per plug.

XBB POWERUNIT

The Strands Pro wiring harness enables quick connection of your lighting to XBB with plug-and-play functionality. The signal is integrated into Output 1, while the position light is connected through Output 2, providing a fast and precise installation. Designed for LED bars with a built-in relay or loads up to 15 A / 180 W, the harness includes a pre-installed switch for the position lights, mounted in the engine compartment for easy change/on/off control. The cable measures 700 mm and is delivered with three DuraSeal heat-shrink sleeves.



Use the QR code to check out the product.

XBB POWERUNIT

Part No. ST-907003

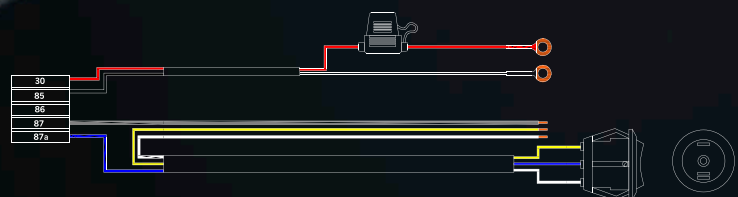



MAX POWER 150W

This DT4PIN-to-DT6 plug cable is ideal when you need a different plug for installation. It is 1600 mm long and works with 12-80 V DC and a max power of 150W.

STRANDS PRO DT-6 TO DT-4 CONNECTOR CABLE

Part No. ST-907006

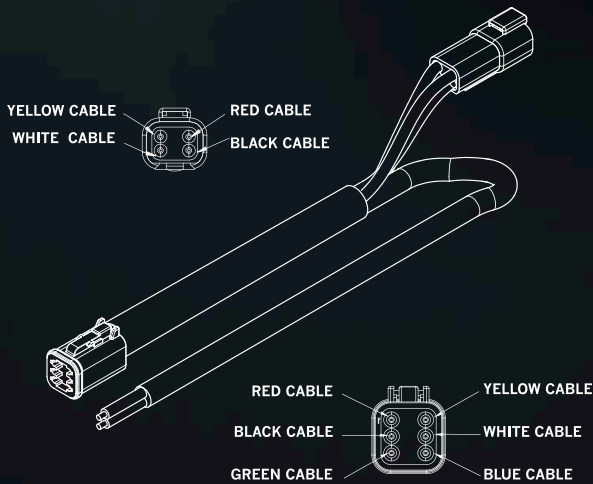

Use the QR code to check out the product.

STRANDS PRO

CONNECTOR SET

Part No. ST-907021 - ST-907030

- ✓ WITHSTANDS 13A DT VERSIONS / 24A FOR DTP VERSIONS
- ✓ MALE AND FEMALE DEUTSCH CONNECTOR VERSIONS
- ✓ EASY TO USE



FRONT

BACK

DT-2 PIN
Part No. ST-907021

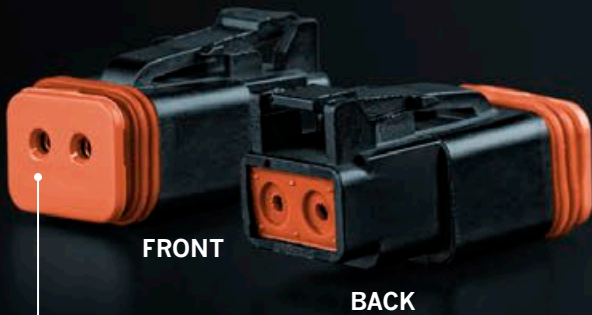

FRONT

BACK

DT-2 PLUG
Part No. ST-907022



FRONT

BACK

DT-3 PIN
Part No. ST-907023



FRONT

BACK

DT-3 PLUG
Part No. ST-907024



FRONT

BACK

DT-4 PIN
Part No. ST-907025



Use the QR code to check out the product.



5 CONNECTORS PER PACKAGE

Strands Pro connector set is sold in units of 5, with 5 connectors of the same type. The connector includes both housing, pins, and a wedge lock.



FRONT

BACK

DT-4 PLUG
Part No. ST-907026



FRONT

BACK

DT-6 PIN
Part No. ST-907027

MALE AND FEMALE DEUTSCH CONNECTORS VERSIONS

Strands Pro connector set are sold in units of 5. The connector includes both housing, pins, and a wedge lock.



FRONT

BACK

DT-6 PLUG
Part No. ST-907028



FRONT

BACK

DTP-2 PIN
Part No. ST-907029



FRONT

BACK

DTP-2 PLUG
Part No. ST-907030

FOR9T ILLUSION

TAIL LIGHTS
Part No. ST-800655 - ST-800658

- ✓ FITS IZE LED FRAMES
- ✓ ALL TAIL LIGHT FUNCTIONS
- ✓ EASY HORIZONTAL AND VERTICAL INSTALLATION

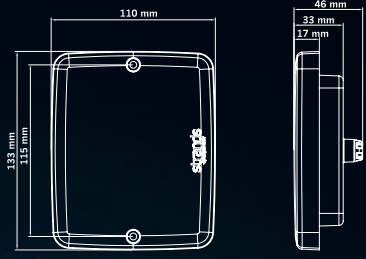

FOG/REVERSE LIGHT
Part No. ST-800658

INDICATOR LIGHT
Part No. ST-800657

**TAIL/BRAKE/INDICATOR,
3 FUNCTION LIGHT**
Part No. ST-800655

TAIL/BRAKE LIGHT
Part No. ST-800656

**HORIZONTAL
OR
VERTICAL**



Use the QR code to check out the products.

FOR9T GEO

POSITION LIGHT / SIDE MARKER

Part No. ST-850465 - ST-850467

- ✓ DARK LENS
- ✓ FOR RUBBER ARMS
- ✓ 4,5W



AMBER SIDE MARKER
Part No. ST-850467
2,5W



RED REAR POSITION
Part No. ST-850466

4,5W



WHITE FRONT POSITION
Part No. ST-850465
2,5W



FITS RUBBER ARMS

The FOR9T Geo (Part No. ST-850465-ST-850467) is a striking Viking-style position light with the FOR9T look. It will fit most rubber arms, such as the Strands Viking rubber arms (Part No. ST-800412-ST-800414/ST-19), and has a diameter of 70,2 mm. It's made of high-quality, corrosion-free polycarbonate and is IP-rated IP67, as a guarantee for a long-lasting product.

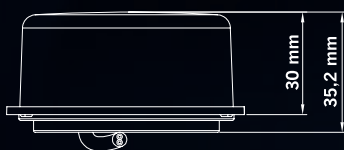

Use the QR code to check out the products.

AWIMEX
YOUR NEED - OUR SOLUTION

strands
-lighting division

FOR9T NO-GLARE

WORK LIGHT

Part No. ST-809259 - ST-809260

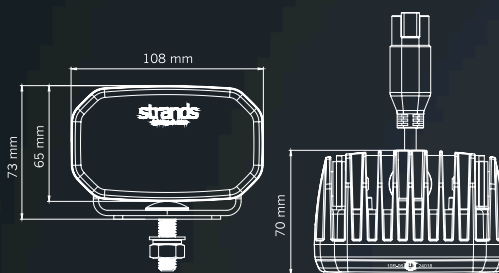

- ✓ NO-GLARE FUNCTION
- ✓ SAFE AND COMFORTABLE WORK ENVIRONMENT
- ✓ DUAL-COLOR POSITION LIGHT
- ✓ 3220 LUMEN

NO-GLARE 31W
Part No. ST-809259



NO-GLARE

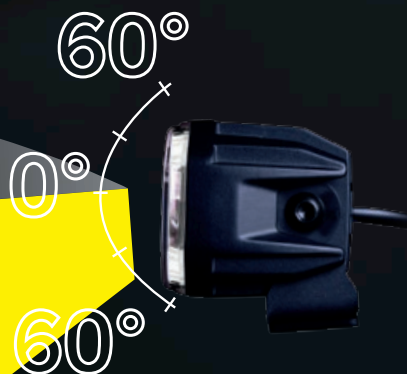

AWIMEX
YOUR NEED - OUR SOLUTION

strands®
-lighting division

SAFE AND COMFORTABLE WORK ENVIRONMENT

The No-Glare functionality provides a comfortable light for you to work in and reduces the risk of dazzling others around you, thus increasing safety. The light ensures others can see you can see others, significantly lessening the risk of accidents and miscommunication.

RED AND AMBER
POSITION LIGHT



NO-GLARE 78W
Part No. ST-809260

78W

NO-GLARE FUNCTION

The lens's groundbreaking configuration gives the FOR9T No-Glare work light an exceptional, user-friendly light output that prevents tired eyes. Thanks to the textured upper part of the lens, the upper part of the beam is softened while the lower maintains its brilliance. The result is a strong illumination that doesn't dazzle your eyes and focuses on the task ahead. FOR9T No-Glare is available in 31 w and 78 W models.

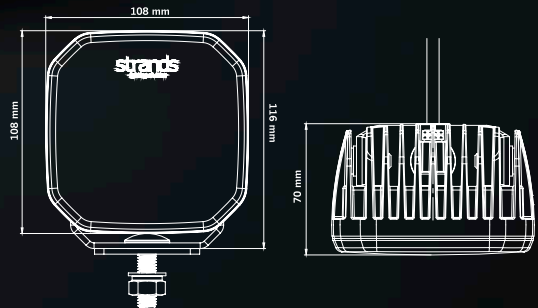

Use the QR code to
check out the products.

AWIMEX
YOUR NEED - OUR SOLUTION

strands[®]
-lighting division

NUUK D-LINE

DRIVING LIGHT 9"

Part No. ST-901021

- ✓ LONGER AND BROADER OUTPUT
- ✓ DARK INTEGRATED POSITION LIGHT
- ✓ 1 LUX @ +800 METERS

13 400 ACTUAL
LUMENS

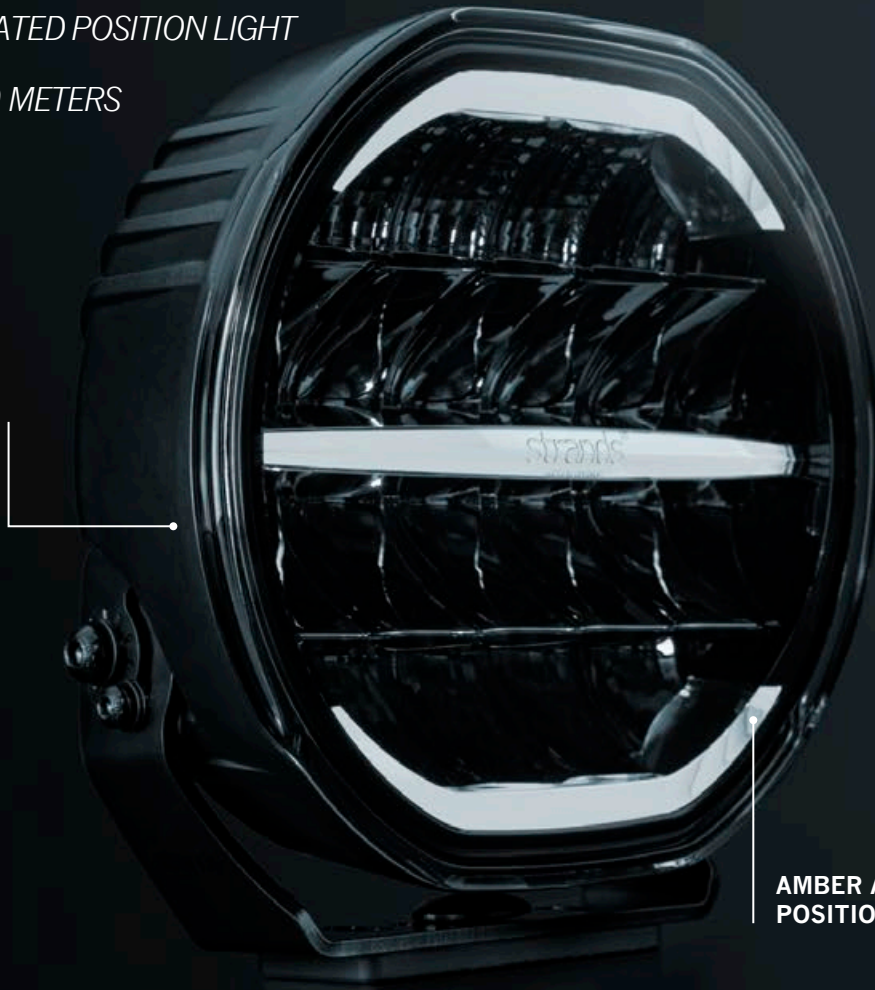

AMBER AND WHITE
POSITION LIGHT

1 LUX @ +800 METERS

The Nuuk D-Line driving light has a new beam pattern. Thanks to the light's unique construction, the output is fuller, longer, and broader than that of the average combo or long-distance beam. With 13,400 actual lumens and 1 lux @ +800 meters in Xperience mode, you can be sure to spot any obstacles from far away. Other lights with this kind of range often have a reduced width and power closer to the vehicle, but the Nuuk D-Line does not, making it easier to spot wildlife and other dangers to the side of the road.



Use the QR code to
check out the product.

AWIMEX
YOUR NEED - OUR SOLUTION

strands[®]
-lighting division

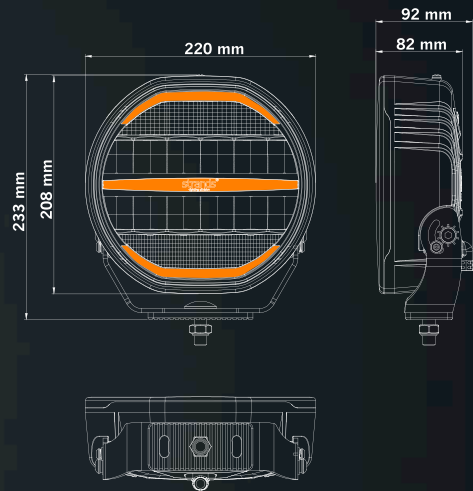

NEW DUAL-COLOR POSITION LIGHT

The position light diodes are built into the reflector, dark and invisible when not in use, and emit a deep, vibrant color when on. The reflector produces a mirror-like effect on the position lights, giving a smooth, lively impression.

MADE FOR DURABILITY

From the inner components and material to the finish of the coating, the D-Line driving light is designed to withstand harsh weather and exposure to the elements. It is IP-rated IP69K, giving it supreme protection against dirt and water. The coating is made to withstand the rigors of the road, with salt, ice, dirt, and temperature changes.

E-MODE

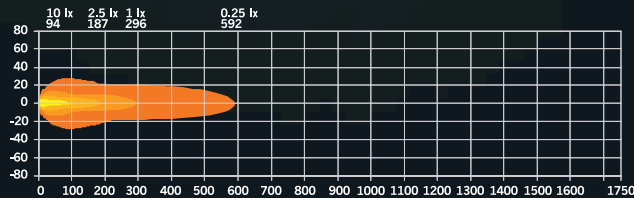

XPERIENCE MODE

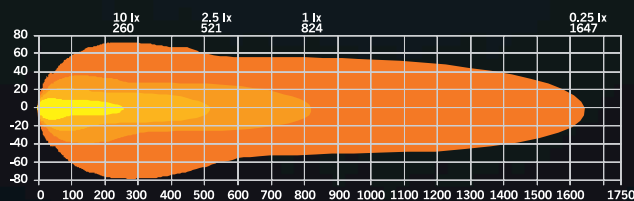

IZE LED ROOF LIGHT

DUO FUNCTION

Part No. ST-903021 - ST-903022

- ✓ IP69K
- ✓ WARNING LIGHT FUNCTION
- ✓ 19 PATTERNS
- ✓ DARK LENS

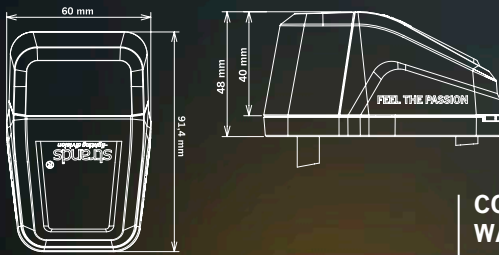

ANGLE MOUNTING BRACKET, LEFT/RIGHT
Part No. ST-903022



CONSUMPTION WARNING LIGHT 4W

CONSUMPTION WHITE 2,2W

ROOF LIGHT
Part No. ST-903021

RUBBER BRACKET

With this angled bracket, you can install the IZE LED roof light (Part No. ST-903021) on any roof. It has ST-61 mm CC and is delivered with the following installation details: Click-in base, screws, washers, bolts, and silicone pad.

AMBER AND WHITE POSITION LIGHT



CONSUMPTION AMBER 1W

A DARK LENS

The dark lens creates a unique signature appearance on any truck. Choose between white or amber position light, while the integrated warning light function keeps you visible and safe.



Use the QR code to check out the products.

IZE LED OG HAMBURGER

TAIL LIGHT

Part No. ST-900016

- ✓ 12-24V
- ✓ 3 FUNCTIONS
- ✓ IP6K9K
- ✓ E- AND D-APPROVED

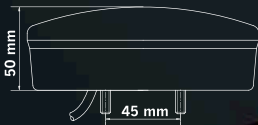

DURABLE

This tail light is IP-rated IP6K9K, manufactured in Europe and designed for easy installation. It has a diameter of 142 mm with 45 mm CC. Operating voltage is 12-24 V with a power consumption of 2.5 W.

RED AND AMBER COLOR LENS

TAIL, BRAKE AND INDICATOR FUNCTION

HALOGEN-LIKE GLOW



Use the QR code to
check out the products.

AWIMEX
YOUR NEED - OUR SOLUTION

strands[®]
-lighting division

FOR9T SPANISH LIGHT

POSITION LIGHT

Part No. ST-903006 - ST-903007

- ✓ DOUBLE-SIDE LIGHT
- ✓ INCLUDES MOUNTING HARDWARE
- ✓ CLASSIC SPANISH LIGHT
- ✓ 3 FUNCTIONS



VOLTAGE 10-40V DC

FLEXIBLE COLOR SETUP

The FOR9T Spanish light is available in two versions: white/amber and red, and amber/amber. This gives you the flexibility to choose a setup that fits both your vehicle's design and your preferred lighting expression.

SPANISH LIGHT 3 FUNCTION

Part No. 1007903006

CONSUMPTION 8W

BUILT TO LAST

The light measures 109 mm in diameter, comes with a 500 mm cable, and includes all required mounting hardware: M12 nut, M12 flat washer, and M12 spring washer for a secure and straightforward installation.



Use the QR code to check out the products.

AWIMEX
YOUR NEED - OUR SOLUTION

strands[®]
-lighting division

A TRUE TIMELESS CLASSIC



FOR9T IS PASSION

As the FOR9T series continues to grow, it allows you to build a cohesive lighting setup across your entire vehicle. With driving lights, tail lights, work lights, and position lights in the same design language, FOR9T makes it easy to achieve a complete and consistent look from every angle. This is lighting driven by passion for design, quality, and detail.

AMBER SPANISH LIGHT A&A
Part No. ST-903007
CONSUMPTION 4W



IP-CLASS IP67

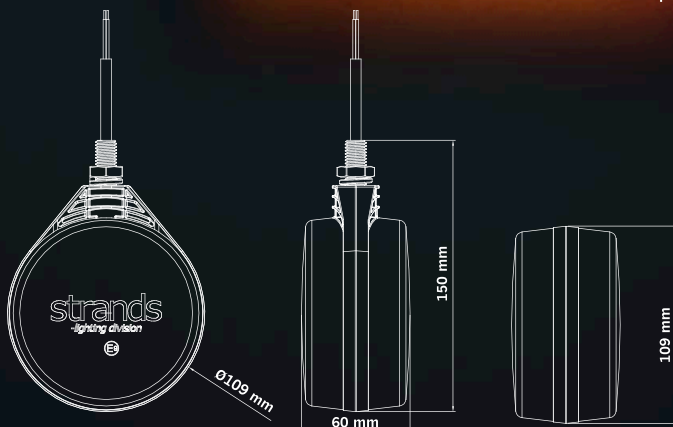

Use the QR code to check out the products.

AWIMEX
YOUR NEED - OUR SOLUTION

strands[®]
-lighting division

BIG ENERGY 2.0

DRIVING LIGHT

Part No. ST-901031

- ✓ DT-4 CONNECTOR
- ✓ 9100 ACTUAL LUMENS
- ✓ E-APPROVED R148/149
- ✓ IP-RATED IP69K

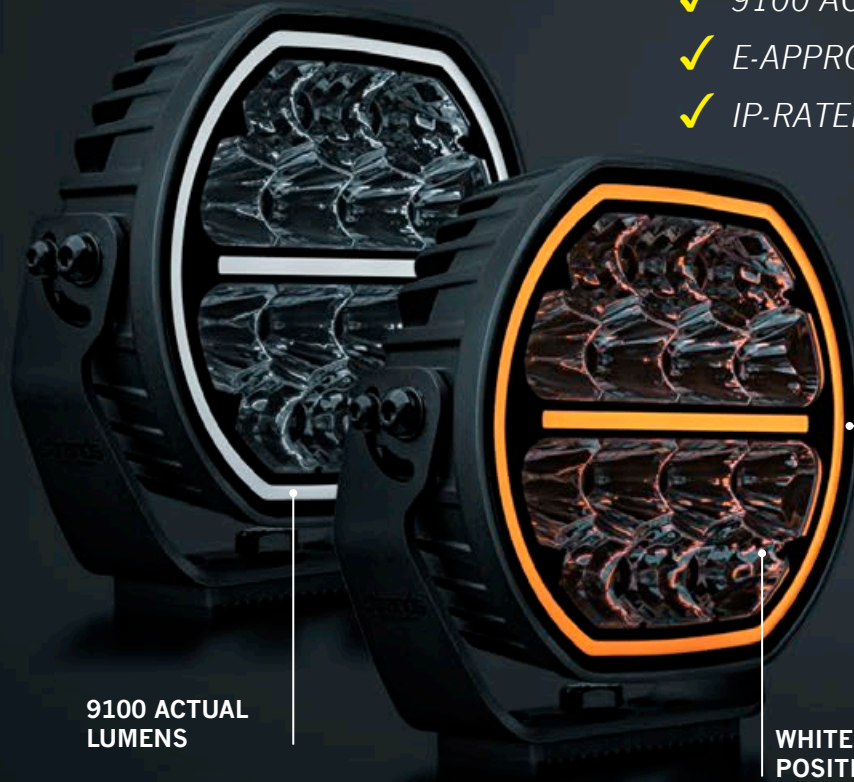

9100 ACTUAL LUMENS

WHITE AND AMBER POSITION LIGHT

E-MODE

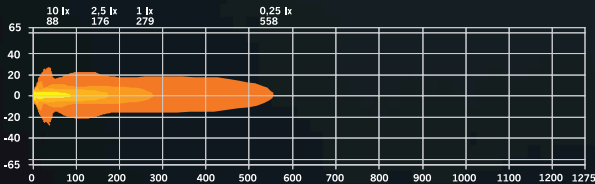

XPERIENCE MODE

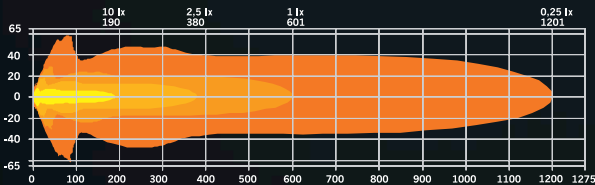

BIG ENERGY 2.0 7"

This is the Big Energy 2.0, with improved output and range. It has a 600-meter range with 9100 actual lumens in Xperience mode. It also has an E-approved mode, which is approved R148/149 with reference number 20. To resist water and dirt, it is IP-rated IP69K. Additionally, it is covered by Strands' unique 3-year warranty. Big Energy 2.0 is easy to connect with a DT4 connector, and it has white and amber position lights. This 7" driving light is a good fit for both cars, LCVs, and heavier vehicles.



Use the QR code to check out the products

AWIMEX
YOUR NEED - OUR SOLUTION

strands[®]
-lighting division

DARK KNIGHT SM6

POSITION LIGHT/WARNING LIGHT

Part No. ST-905101, ST-809512 - ST-809514

- ✓ ONLY 8 MM DEEP
- ✓ COMPACT 120 MM LENGTH
- ✓ E-APPROVED



REAR POSITION LIGHT

Part No. ST-809513

CONSUMPTION 9W

POSITION LIGHT

Part No. ST-809514

CONSUMPTION 2,6W

SIDE MARKER

Part No. ST-809512

CONSUMPTION 3,3W

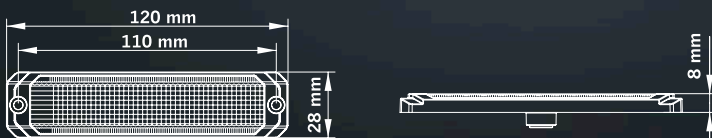

PERFECT FOR YOUR TRUCK



DIRECTIONAL WARNING LIGHT

Part No. ST-905101

CONSUMPTION 6,5W

E-APPROVED

The 6 LEDs produce a powerful glow, guaranteeing high visibility and eye-catching style. Thanks to the incredibly low power consumption, 0,9-3,3 W, you can install as many as you like without draining too much power. The SM6 is E-approved ECE R148 and EMC-certified ECE R10.

INCREDIBLY SLIM

As it's available as a side marker and red and white position light, you can get an undeniable style around your vehicle. It measures 120x8x28 mm with 110 mm CC, and a 600 mm cable makes it easy to install anywhere.



Use the QR code to check out the products

AWIMEX
YOUR NEED - OUR SOLUTION

strands[®]
-lighting division

FOUR SIMPLE STEPS TO FIND YOUR RRS SOLUTION

WEBSITE

Go to strandseurope.com

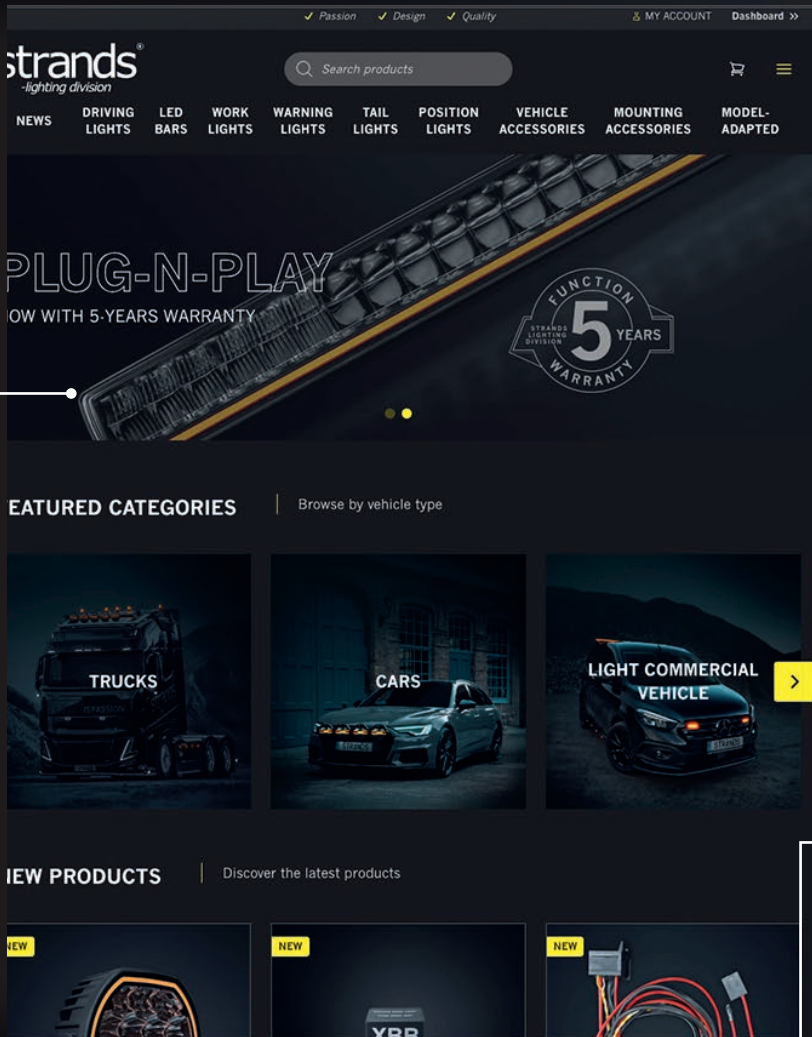

CHOOSE BRAND & MODEL

Choose your brand and your model on your vehicle

TYPE

Choose roof rack system and see all options for your vehicle

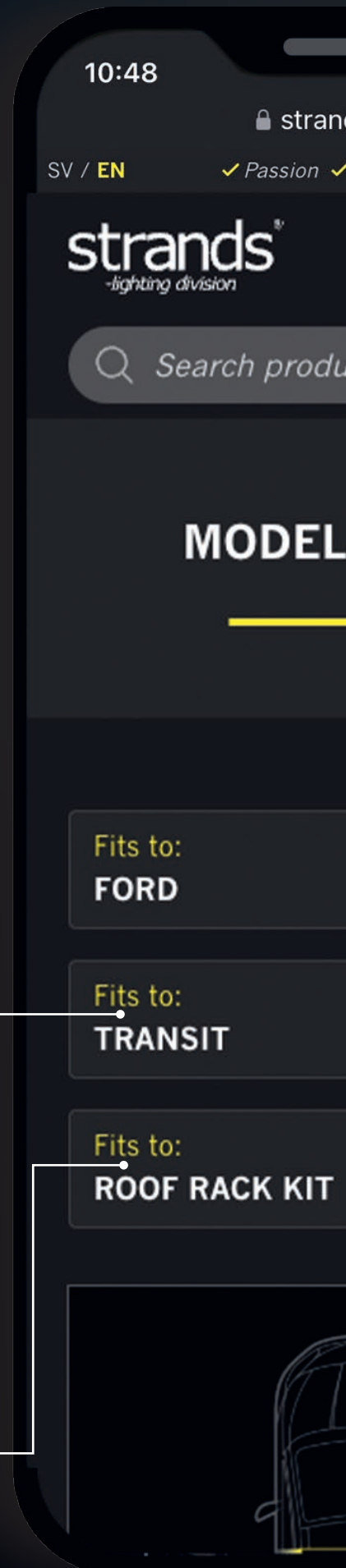

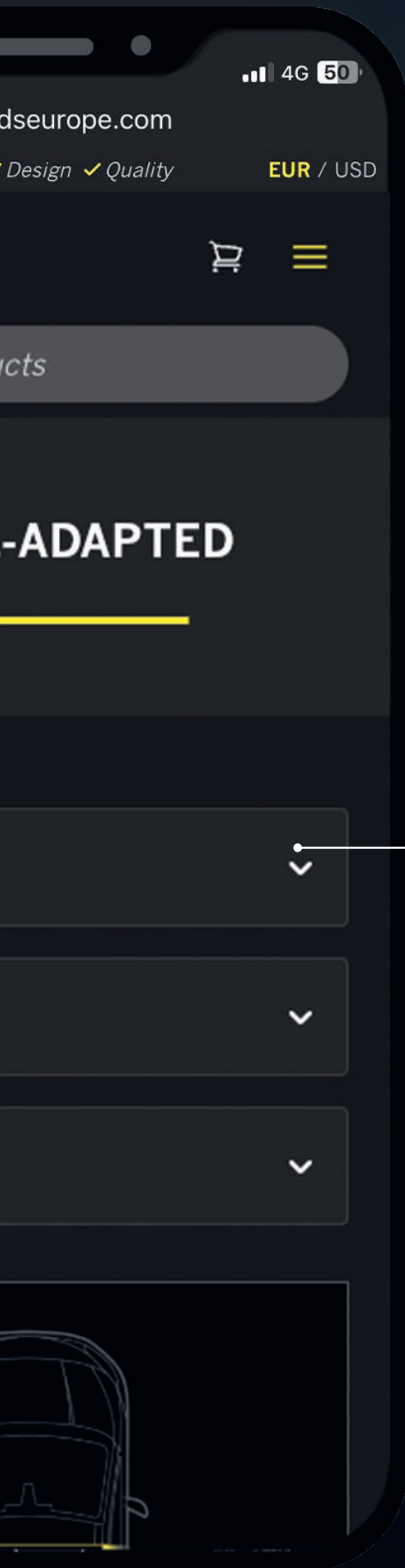

CHOOSE BRAND & MODEL

Choose your brand and your model on your vehicle



WHY PROS CHOOSE IT

Safety, efficiency, and adaptability. With the roof rack system professional drivers will get a reliable product that will perform well in any work situation. E-approved, crash-tested, and easy to install: all to keep both driver and cargo safe on the road and in the work place. The C-Rack is installed with plug-and-play and available for a wide range of different LCV models.



Scan the QR-code for tutorial

CRUISE LIGHT C-RACK

- ✓ ADJUSTABLE ROOF RACKS
- ✓ ECE-R65 CLASS 1 & 2
- ✓ EASY INSTALLATION
- ✓ 180° ANGLE

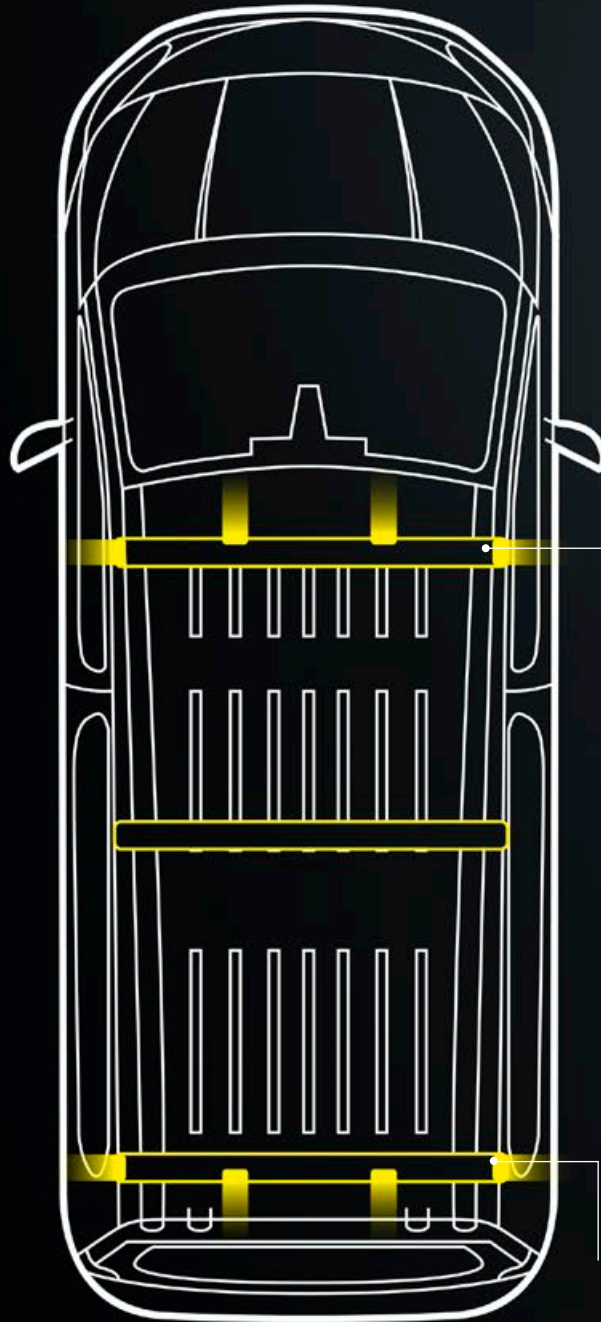

You can have 2 or 4 lamps on the front roof rack, and either two or no end-caps.

You can have 2 or 4 lamps on the rear roof rack, and either two or no end-caps.

WHY IT STANDS OUT

The C-rack has two additions: The FLEX Anchor and the FLEX Load stop. They can be installed by inserting and twisting them into place in the groove along the length of the rack. They can be adjusted without needing to remove the end cover, making your workday smooth and efficient.



The roof rack system will keep you and your cargo safe during long workdays. The FLEX Load stop will keep the cargo secure on the rack by providing stops on the sides.



When working in demanding environment, transport safety is key. The cargo can be transported securely by attaching, e.g., a tensioning belt or strap to the FLEX Anchor.

This system stands out for its versatility and adaptability. Choose the number of end-cap and directional warning lights you need to ensure you are seen from all directions, and use the rack with the FLEX accessories to maximize the available load capacity. The combination of visibility, load capacity, and model-specific fit makes the roof rack system a must-have for any professional.



Use the QR code to check out the product.

AWIMEX
YOUR NEED - OUR SOLUTION

strands[®]
-lighting division

ROOF RACK SYSTEM FOR COMMERCIAL VEHICLES

This is more than a rack. It's a high-functioning, model-adapted system that combines load capacity with integrated, high-visibility warning lighting. Designed to use existing factory mounting points, it eliminates the need for drilling or modifications. Each unit is ECE R65 approved (Class 1 & 2), crash-tested, and built with non-corrosive materials to endure daily professional use.

- ✓ FITS 34 LCV MODELS
- ✓ 213 CONFIGURATION OPTIONS
- ✓ INTEGRATED LED WARNING LIGHTS
- ✓ LOAD CAPACITY: 50 KG PER RACK
- ✓ PLUG-AND-PLAY INSTALL USING ORIGINAL FIX POINTS – NO DRILLING
- ✓ ECE R65 CLASS 1 AND 2 APPROVED
- ✓ WEATHER-RESISTANT AND CORROSION-PROOF STRUCTURE
- ✓ CRASH-TESTED, NO CORROSION AND POWERFUL WARNING LIGHT

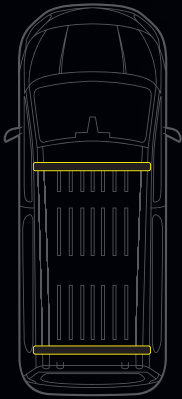

CRUISE LIGHT C-RACK ROOF RACK SYSTEM SUITABLE KIA PV5

- ✓ INSTALL IN LESS THEN 15 MINUTES
Part No. ST-RRS5250200



CRUISE LIGHT C-RACK ROOF RACK SYSTEM SUITABLE KIA PV5

- ✓ INTEGRATED HIGH-VISIBILITY WARNING LIGHTS
Part No. ST-RRS5250240



CRUISE LIGHT C-RACK ROOF RACK SYSTEM

SUITABLE KIA PV5

✓ INTEGRATED HIGH-VISIBILITY WARNING LIGHTS
Part No. ST-RRS5250244



CRUISE LIGHT C-RACK ROOF RACK SYSTEM

SUITABLE KIA PV5

✓ INSTALL IN LESS THEN 15 MINUTES
Part No. ST-RRS5250300



CRUISE LIGHT C-RACK ROOF RACK SYSTEM

SUITABLE KIA PV5

✓ INTEGRATED HIGH-VISIBILITY WARNING LIGHTS
Part No. ST-RRS5250340



CRUISE LIGHT C-RACK ROOF RACK SYSTEM

SUITABLE KIA PV5

✓ INTEGRATED HIGH-VISIBILITY WARNING LIGHTS
Part No. ST-RRS5250344



ADDRESS

Fabriksgatan 27
272 36 Simrishamn

CONTACT US

Phone: 0414-160 50
E-mail: info@awimex.se



YOUTUBE. *Subscribe at Strands Lighting Division for innovative lighting in action and get detailed information about our products.*



LINKEDIN. *Follow us at Strands Group AB for industry insights, news, and exciting updates.*



WEBSITE. *Visit www.strandseurope.com for detailed information about our products.*



INSTAGRAM. *Follow us at @strandslightingdivision for inspiration, exciting news, and participate in competitions.*



FACEBOOK. *Like Strands Lighting Division, engage in discussions and be the first to know about product news.*

