

Prices valid from 01.01.2026 - 31.03.2026

BREAKING NEWS



Q1 2026

AWIMEX
YOUR NEED – OUR SOLUTION

strands[®]
-lighting division

STAY UPDATED

Subscribe to our newsletter to stay updated on Strands' latest product releases. Once a week you'll receive in-depth guides on vehicle lighting, special announcements, and essential information about exciting new products.



Subscribe to our newsletter to receive the latest news on vehicle lighting



READ STRANDS CATALOGS ONLINE

Did you know you can read this and all of our catalogs online? Scan the QR code to access previous Breaking News catalogs, as well as catalogs for model-adapted warning lights, agricultural vehicles, off-highway, trucks, product series, and more. If you're looking for inspiration for your next lighting project, this is the place to start.



Check out the catalogs here

MODEL-ADAPTED LIGHTING SOLUTION

Strands Lighting Division proudly presents a revolutionary range of model-adapted lighting solutions for light commercial vehicles, available for over 70 vehicle models. These solutions include integrated roof racks, roof bars, and grille-mounted LED systems. Designed for professional use, they combine high-performance lighting with OEM-grade fit and easy installation. Whether you're an LCV dealer, upfitter, or installer, our plug-and-play concepts help you save time, reduce installation errors, and deliver premium solutions to your customers. These solutions are crash-tested, ECE-approved, corrosion-resistant, and include a unique 3-year functional warranty.



Check out our model-adapted



FUNCTION WARRANTY THREE TO SIX YEARS

More than design, quality, and performance, we offer peace of mind. All products in the Strands Lighting Division range are covered by a unique function warranty, valid for 3 to 6 years. The warranty is unique on the market and covers faults related to manufacturing, materials, and assembly. Our goal is to improve service, increase customer satisfaction, and emphasize our brand's quality.

▶ YOUTUBE



TRUCK TOUR

Meeting different drivers and seeing all the passion that goes into creating each unique truck is a huge inspiration and pure joy. Every fair means an opportunity to see the multitude of ways you use Strands' products. If you're curious about some of the trucks and drivers we've met during different fairs over the years, take a look at the Truck Tour playlist. In each episode, we get to listen to a driver guiding us through the look and products of their truck.



Follow us
on YouTube

HOW TO

Want a deep dive into your favorite products? On our YouTube channel, you'll see the products up close and learn about their functions and installation. If you're wondering how to connect the wires, what the lighting patterns look like, or want a close-up of the design, these informative videos are the place to start.



📷 INSTAGRAM



INSTAGRAM

Follow us on Instagram to participate in competitions, see our collaborations and follower content, and be the first to learn about exciting new product releases. We love to see all the creative ways you use your Strands products in action, so tag us @strandslightingdivision to be featured in our highlights section.



Follow us
on Instagram

IZE LED TORPEDO

Part No. ST-850426 - ST-850427

- ✓ 18W
- ✓ SMOKED LENS
- ✓ WHITE AND AMBER POSITION LIGHT

✓ **DUAL POSITION LIGHT
AND WARNING LIGHT**

Choose between a white or amber position light and combine it with the warning light for extra effect. Light up your passion for your work and style every mile of the road.

668:-

RECOMMENDED RETAIL PRICE
EXCL. VAT

✓ 10-32V DC

**SILVER ARROW
TORPEDO**

Part No. ST-850427

**BLACK BULLET
TORPEDO**

Part No. ST-850426



Use the QR code to
check out the products

AWIMEX
YOUR NEED - OUR SOLUTION

strands[®]
-lighting division

IZE LED DOUBLE BURNER

Part No. ST-850459, ST-850458

- ✓ 10W
- ✓ WHITE AND AMBER
- ✓ E-APPROVED AS FRONT POSITION LIGHT AND SIDE MARKER LIGHT
- ✓ 10-32V DC
- ✓ DOUBLE BURNER

✓ DUO COLOR AND WARNING LIGHT

In addition to attitude and style, the IZE LED double burner has a built-in warning light for extra visibility. The amber warning light has 21 light patterns to fit any situation. You can synchronize up to 12 double burners or Dark Knight Strobe lights for a complete look around your truck.

279:-

RECOMMENDED RETAIL PRICE
EXCL. VAT

SILVER ARROW DOUBLE BURNER

Part No. ST-850458



279:-

RECOMMENDED RETAIL PRICE
EXCL. VAT

BLACK BULLET DOUBLE BURNER

Part No. ST-850459



✓ CORROSION-FREE

Be the center of attention with this undeniable old-school look. We've taken the classic double burner and driven it into the future. You'll recognize the style and shape, but with a quality and feel thoroughly updated to fit the modern driver.

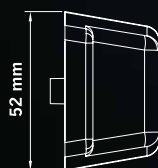
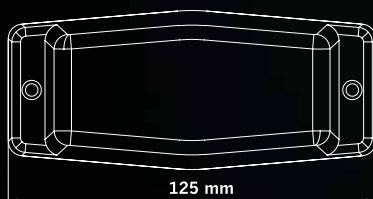

Use the QR code to
check out the products

AWIMEX
YOUR NEED - OUR SOLUTION

strands[®]
-lighting division

IZE LED OG 9"

- ✓ DURABLE AND EASY TO INSTALL
- ✓ 1 LUX @ 500 M
- ✓ 12 000 LUMEN



✓ **COLOR TEMPERATURE**
4500K



2495,-

RECOMMENDED RETAIL PRICE
EXCL. VAT

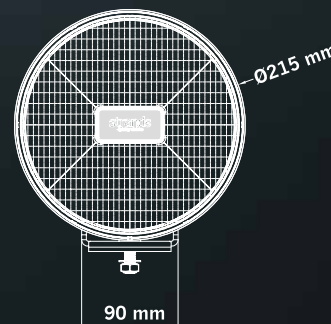
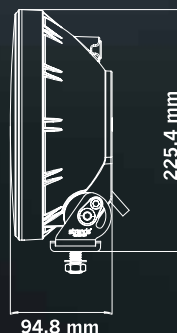

E-MODE

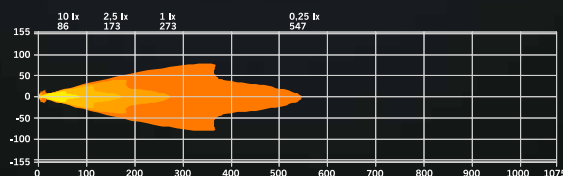

XPERIENCE MODE

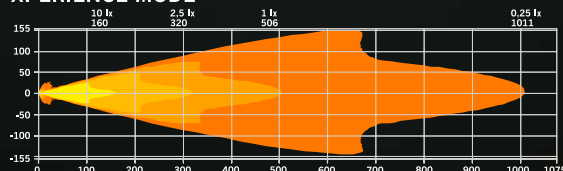

Use the QR code to
check out the product.

Part No. ST-270945

XPERIENCE-MODE

Consumption 172W
Actual lumen 12 000 lm
1 lux @ 506 m

E-MODE

Consumption 30W
Actual lumen 3220 lm
1 lux @ 273 m

Voltage 12-36V DC
IP-Class IP68/69K
Color temperature 4500K
Position light White and amber
Color lens Clear
Color LED White and amber
Connection Cable
Cable length 2500 mm
Material housing Aluminium

Material lens Polycarbonate
Depth 94,8 mm
Height including bracket 225,4 mm
Diameter 215 mm
Operating temperature -40°C - +60°C
E-approved ECE R148, R149
Ref 20
EMC-certificate ECE R10



FEEL THE PASSION

STRANDS

AWIMEX
YOUR NEED - OUR SOLUTION

strands[®]
-lighting division

IZE LED OG REX

Part No. ST-901012

- ✓ DRIVING LIGHT
- ✓ 1 LUX @ 412 M
- ✓ DUO POSITION LIGHT
WARM WHITE AND AMBER
- ✓ E-APPROVED

✓ 9400 ACTUAL LUMENS

The OG REX has an optimized beam pattern with two modes, E-mode and Xperience mode. With Xperience mode it delivers 9400 actual lumens for a range of 410 meters, and the E-mode is E-approved. Both modes provides a balanced forward and sideways visibility. Thanks to the 4500 K color temperature, the output is clear and bright.

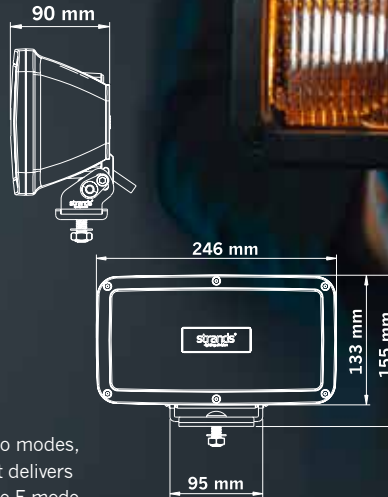

2695:-

RECOMMENDED RETAIL PRICE
EXCL. VAT



Use the QR code to
check out the products

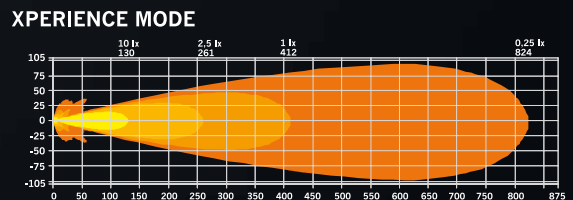
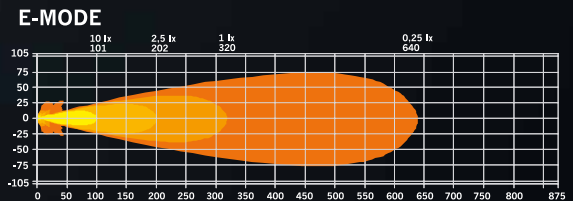

AWIMEX
YOUR NEED - OUR SOLUTION

strands[®]
-lighting division

IZE LED OG OVAL

- ✓ DRIVING LIGHT
- ✓ 4500K DRIVING LIGHT COLOR TEMPERATURE
- ✓ WARM WHITE WITH 3500K / AMBER POSITION LIGHT

Part No. ST-901011

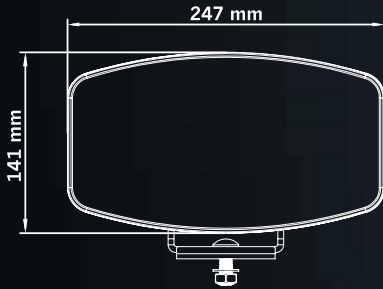

2495:-

RECOMMENDED RETAIL PRICE
EXCL. VAT

✓ 11 800 ACTUAL LUMENS

IZE LED OG Oval delivers an impressive 11,800 actual lumens with a range of over 480 meters in Xperience mode. The E-approved mode is ideal for European roads and reduces glare in rain or snow. With two modes, you can adjust the light to suit driving conditions. An optimized beam pattern ensures excellent forward and side visibility. The 4500 K color temperature creates a clear and bright output.

OLD SCHOOL
STYLE

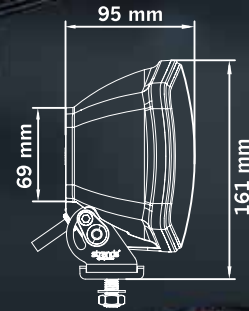

E-MODE

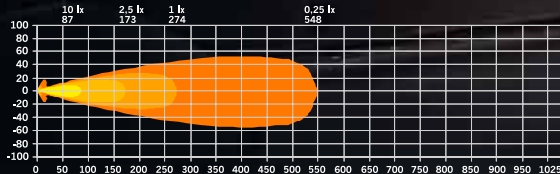

XPERIENCE MODE

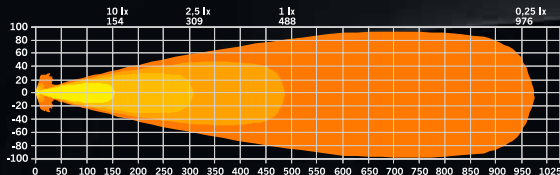

Use the QR code to check out the products

AWIMEX
YOUR NEED - OUR SOLUTION

strands®
-lighting division

IZE LED OG WORK LIGHT

Part No. ST-906000

- ✓ RETRO OLD SCHOOL DESIGN
- ✓ 4500K COLOR TEMPERATURE
- ✓ UP TO 3500 LM

899.-

RECOMMENDED RETAIL PRICE
EXCL. VAT

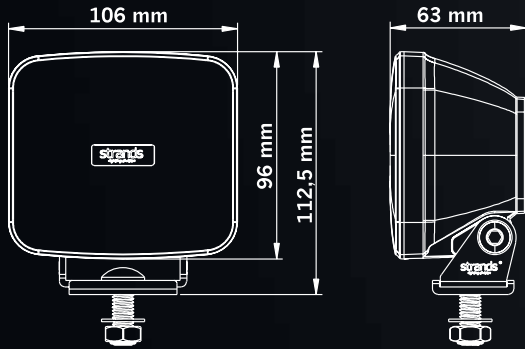

✓ **CONSUMPTION**
42W

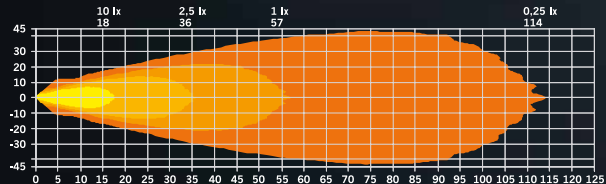

✓ **WIDE BEAM AND 3400 ACTUAL LUMENS**

No matter where you work, you need a work light that's bright and comfortable. With its 3400 lumens and 57-meter range, the OG provides powerful and clear illumination for any jobsite. A 4500 K color temperature delivers a bright, crisp output.

✓ **COLOR LED**
WHITE



Use the QR code to
check out the products



AWIMEX
YOUR NEED - OUR SOLUTION

strands[®]
-lighting division

IZE LED OG WORK LIGHT WITH POSITION LIGHT

Part No. ST-906001

- ✓ RETRO OLD SCHOOL DESIGN
- ✓ 4500K COLOR TEMPERATURE
- ✓ RED AND AMBER POSITION LIGHT
- ✓ LOOSE CABLE WITH SEPARATE DT-4

✓ RED AND AMBER POSITION LIGHT

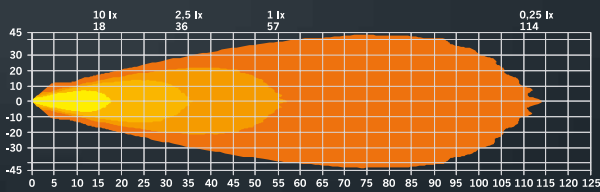

✓ **COLOR LED**
WHITE, RED AND AMBER

1196:-

RECOMMENDED RETAIL PRICE
EXCL. VAT

✓ **DURABLE AND EVERYTHING YOU NEED FOR INSTALLATION**

The OG work light is IP-rated IP68/69K for maximum resistance to rain and dirt. Its high-quality aluminum housing and PC lens ensure a long lifespan, and the OG is covered by Strands' market-leading 3-year warranty. Everything you need for installation is included in the package: bracket, M10 bolt, washer, nut, and rubber pad. It's installed using a 1 m cable.

✓ **CONSUMPTION**
42W



Use the QR code to check out the products

AWIMEX
YOUR NEED - OUR SOLUTION

strands
-lighting division



IZE LED LIGHTHOUSE

Part No. ST-905003

- ✓ *RETRO DESIGN*
- ✓ *FULL LED*
- ✓ *NO CORROSION*
- ✓ *ECE R65 APPROVED*

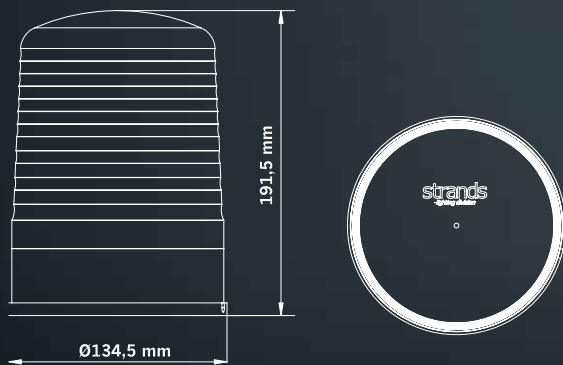

✓ *EASY TO INSTALL*

Designed for quick and secure installation, the IZE LED Lighthouse includes everything needed for mounting—300 mm cable, M4 screws, ST4 self-tapping screws, nuts, washers, and a rubber pad. It measures 191.5 mm in height, 135 mm in diameter, and 90.9/103.9 mm CC. Every part is engineered for a tight, lasting fit.



✓ *COMPLETELY MECHANICAL*

995.-

RECOMMENDED RETAIL PRICE
EXCL. VAT



✓ *POWERFUL AMBER BEACON*

The textured lens is the perfect canvas for the powerful amber beam, and it's E-approved R65. It provides clear, attention-grabbing illumination in all conditions. The steady rotation pattern provides high visibility and safety on any job.



Use the QR code to
check out the products

AWIMEX
YOUR NEED - OUR SOLUTION

strands[®]
-lighting division

IZE LED MELON

PART NO. ST-903000

- ✓ 1 LAMP, 6 COLORS
- ✓ BUILT IN MEMORY
- ✓ EASY TO MOUNT, PERFECT FOR YOUR TRUCK
- ✓ A NEW ERA OF LED INTERIOR LIGHTS

✓ IP-CLASS
IP50

399:-

RECOMMENDED RETAIL PRICE
EXCL. VAT

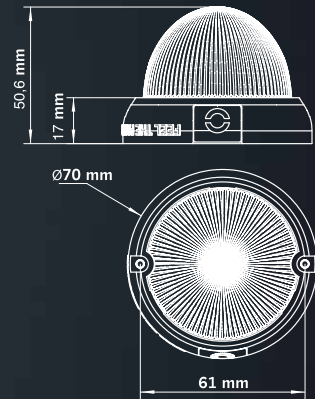

INTERIOR LIGHT
Part No. ST-903000



See the different
colors here

CLICK TO
CHANGE
COLOR

✓ CONSUMPTION
2,9W



✓ MULTIVOLT AND SCRATCHPROOF

Melon is engineered to provide maximum durability and reliability. Built with a scratchproof PC lens and chrome ring, it's designed to handle the demands of life on the road while maintaining a stylish, professional look. With multivolt capability (12-24 V) and ultra-low power draw, this truck cab LED light combines top performance with energy efficiency.



Use the QR code to
check out the product.

AWIMEX
YOUR NEED - OUR SOLUTION

strands®
-lighting division

DARK KNIGHT IZE LED

FROM
773:-

RECOMMENDED RETAIL PRICE EXCL. VAT

Part No.	
ST-800620	773:-
ST-800621	1025:-
ST-800622	1025:-
ST-800623	773:-
ST-800624	899:-

RUBBER GASKET

Part No. ST-800612

Part No.	
ST-800625	150:-
ST-800626	150:-
ST-800612	116:-

RECOMMENDED RETAIL
PRICE EXCL. VAT



✓ E-APPROVED

The series is fully E-approved, ideal for trucks, trailers, pickup trucks, construction equipment and other similar vehicles.

✓ CUSTOMIZATION

Customize your lamp with premium chrome rings. Choose between Light Chrome (Part No. ST-800625) or Dark Chrome (Part No. ST-800626).

DYNAMIC START UP



3 FUNCTION TAIL LIGHT

Part No. ST-800621 (Left), ST-800622 (Right)

DYNAMIC INDICATOR



INDICATOR LIGHT

Part No. ST-800623



TAIL/BRAKE LIGHT

Part No. ST-800620

REVERSE/FOG LIGHT

Part No. ST-800624

✓ **ALL BLACK**

Release your dark side with the all-black versions of IZE LED. Dark Knight comes with a dark tinted lens and dark chrome ring.

IZE LED SQUARE

- ✓ E-APPROVED
- ✓ CLEAR, DARK, AND COLORED LENSES
- ✓ ALL TAIL LIGHT FUNCTIONS
- ✓ 115 MM CC

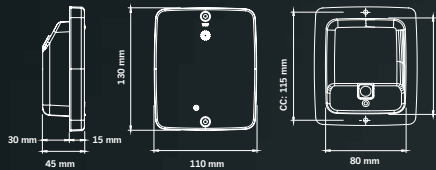

✓ ALL TAIL LIGHT FUNCTIONS

You can find all tail light functions in the IZE LED series, in many combinations. Tail lights, brake lights, reverse lights, as well as indicators, warning lights, and fog lights. Everything you need to stay safe and visible in any weather.



FROM 699:-

RECOMMENDED RETAIL PRICE EXCL. VAT

✓ OUR BEST-SELLING LIGHT OF ALL TIME

Strands Lighting Division's best-selling light of all time. The IZE LED series has revolutionized the market and consists of rectangular and round lights in clear, dark, or colored lenses, offering different functions for various needs.

✓ E-APPROVED

Loaded with power and cutting-edge features, it captivates from every angle and adapts effortlessly to various vehicles. It's fully E-approved, the installation is a breeze, and its quality remains high regardless of year or mileage.

✓ 24V DC

✓ SMOOTH INSTALLATION

Thanks to its size, it's easy to replace your outdated lights with the IZE LED. By using the IZE LED frames or rubber housings for installation, it's easy to install and customize your look.



Use the QR code to check out the product.

AWIMEX
YOUR NEED - OUR SOLUTION

strands[®]
-lighting division



AWIMEX
YOUR NEED - OUR SOLUTION

strands[®]
-lighting division

IZE LED ACCESSORIES



Use the QR code to check out the product.

✓ PROTECT YOUR VEHICLE

For a durable and straightforward installation of your IZE LED tail light, use the IZE LED rubber housing. It protects both the light and the vehicle from corrosion and vibration.

382,50:-

RECOMMENDED RETAIL PRICE
EXCL. VAT

IZE LED RUBBER HOUSING SINGLE

Part No. ST-800112

IZE LED RUBBER HOUSING DOUBLE

Part No. ST-800113



505:-

RECOMMENDED RETAIL PRICE
EXCL. VAT



The IZE LED lights can also be installed using the IZE LED rubber gasket (Part No. ST-800112-P)

85,50:-

RECOMMENDED RETAIL PRICE
EXCL. VAT

351:-

RECOMMENDED RETAIL PRICE
EXCL. VAT

✓ 4 LED DIODES

LED license plate lighting with a black frame and clear glass. The lamp has 4 LED diodes that illuminate the license plate. Elegant design and two screw holes in the frame facilitate the assembly process.



Use the QR code to check out the product.



- ✓ 24V DC
- ✓ 2,5 M CABLE

LICENSE PLATE LIGHT

Part No. ST-800033

IZE LED FRAME

Part No.
ST-800635
ST-800636
ST-800637
ST-800638
ST-800639
ST-800640

✓ 1-5 X SQUARE



FROM
365:-

RECOMMENDED RETAIL PRICE
EXCL. VAT

ST-800635	365:-
ST-800636	521.50:-
ST-800637	521.50:-
ST-800638	939:-
ST-800639	990.95:-
ST-800640	1149:-

✓ HORIZONTAL AND VERTICAL OPTIONS

The frame is available in various sizes. Choose between 1, 2, 3, 4, or 5 to tailor your lighting experience. They come with horizontal and vertical options, allowing you to create the expression that suits you the best.



✓ EASY TO PAINT IN YOUR
PREFERRED COLOR

With its modern design, the frame can be painted effortlessly in any color that aligns with your style, enhancing your vehicle's aesthetics.



Use the QR code to
check out the product.

✓ STYLISH, SEAMLESS,
AND EFFORTLESS MOUNTING
IZE LED Frame is the ideal housing for your IZE LEDs. The installation is easy and seamless, and you can effortlessly replace the lights when needed.

AWIMEX
YOUR NEED - OUR SOLUTION

strands[®]
-lighting division

SIBER

DOUBLE ROW

FROM
1755,-

RECOMMENDED RETAIL PRICE EXCL. VAT

Part No.	
ST-809425	1755,-
ST-809426	2295,-
ST-809427	3129,-
ST-809428	5009,-
ST-809429	5739,-
ST-809430	6679,-

ST-809425 (8") - ST-809430 (50")



30 000 LUMEN

✓ A NEW EXTREME OUTPUT

The Siberia XP Double Row LED bar is available in 8" to 50" models, with an output up to 100% stronger than previously. In Xperience mode, it achieves 4300 - 30 000 actual lumens, with a range of 544-1258 meters @ 1 lux. The E-mode is E-approved R148/149 with reference number 20, suitable for European drivers and poor weather conditions. Based on your requirements, the different models have extended or long-distance beam patterns. A color temperature of 5700K ensures a bright and clear illumination. The IP rating of IP68/IP69K ensures high protection against dirt and water. 20" and above feature the Hello function and an integrated relay. Siberia XP is covered by Strands Lighting Divisions' 3-year function warranty.



Use the QR code to check out the products

AWIMEX
YOUR NEED - OUR SOLUTION

strands[®]
-lighting division

RIA XFP

SINGLE ROW

FROM
1643:-

RECOMMENDED RETAIL PRICE EXCL. VAT

Part No.

ST-809411	1 643:-
ST-809412	2 462:-
ST-809413	3 037:-
ST-809414	3 899:-
ST-809415	4 684:-



**WHITE AND YELLOW
POSITION LIGHT**

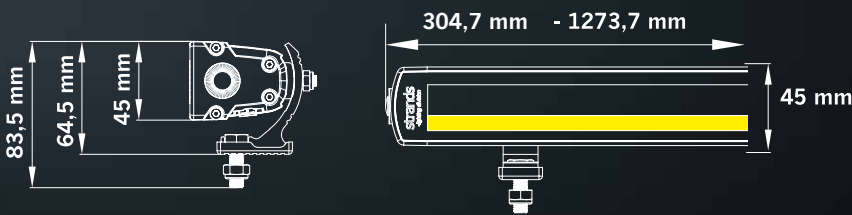

ST-809411 (12") - ST-809415 (50")



✓ **XPERIENCE MODE AND E-MODE**

Get ready to experience the Siberia XP Single Row LED bar. It's available in 12" to 50" models, producing 3620-16500 actual lumens in Xperience mode. They have optimized, extended, or long-distance beam patterns, ranging between 454 and 878 meters. The E-mode is E-approved R148/R149 with reference number 20. The 5700 K color temperature ensures a crisp and clear illumination. It's incredibly durable and can withstand vibrations, rough roads, and hard use. With an IP rating of IP68/IP69K, it has high protection against dirt and water. 20" and above feature the Hello function and an integrated relay. Siberia XP is covered by Strands Lighting Divisions' 3-year function warranty.

16 500 LUMEN



Use the QR code to check out the products

AWIMEX
YOUR NEED - OUR SOLUTION

strands[®]
-lighting division

NUUK D-LINE LED BAR



Use the QR code to check out the products.

- ✓ 19 600 LM
- ✓ 1 LUX @ 580 M

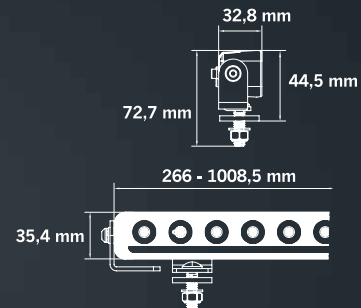

✓ XPERIENCE BOOST MODE

The beam pattern should be superb and perfectly tailored to boost the high beam, adding range and brightness. We added the Xperience mode, a powerful feature, so you can adapt quickly to changing weather conditions.

10''

Part No. ST-809451

1595:-

RECOMMENDED RETAIL PRICE
EXCL. VAT



E-MODE

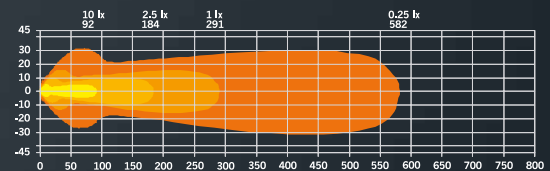

XPERIENCE MODE

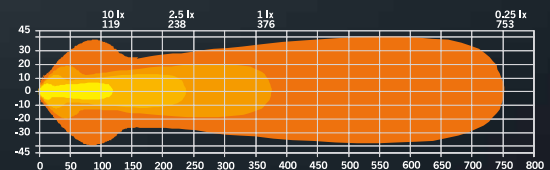

✓ CONTEMPORARY DESIGN

The duo-color position light in white and amber adds an attention-grabbing touch, underlining the dark look of the housing and lens. Any driver can achieve increased safety and visibility with 10'' - 40'' LED bar models, Xperience mode, and optimized or extended beam patterns.

20''

Part No. ST-809452

2239:-

RECOMMENDED RETAIL PRICE
EXCL. VAT



E-MODE

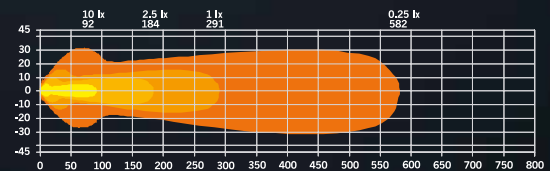

XPERIENCE MODE

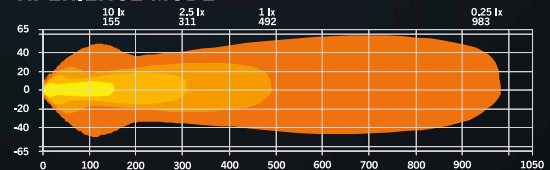

30''

Part No. ST-809453

2956:-

RECOMMENDED RETAIL PRICE
EXCL. VAT



E-MODE

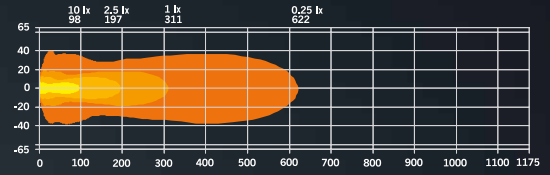

XPERIENCE MODE

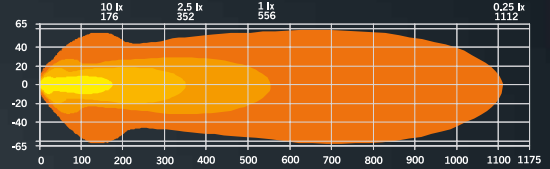

✓ FITS ALL VEHICLES

Thanks to the slim housing and variety of sizes, drivers of cars, LCVs, and trucks can all find a D-Line to fit their needs. The E-approved mode is suitable for European roads. With the Xperience mode, the output gets a massive boost that is suitable for the darkest nights.

40''

Part No. ST-809454

3756:-

RECOMMENDED RETAIL PRICE
EXCL. VAT



E-MODE

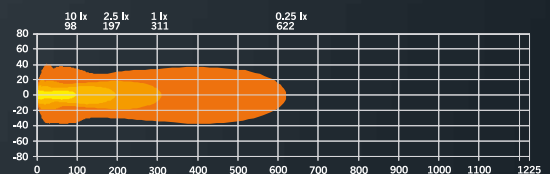

XPERIENCE MODE

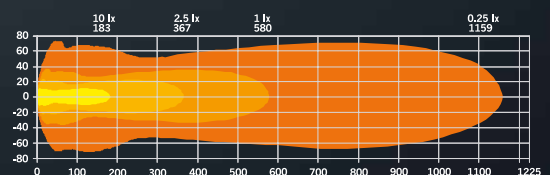

2796:-

RECOMMENDED RETAIL PRICE
EXCL. VAT

NUUK D-LINE LED BAR 20''

Part No. ST-809455



✓ EVERYTHING IS INCLUDED

The Nuuk D-Line has a built-in relay and cable harness. It's slim and lightweight, which makes it easy to place. You'll also find everything you need for installation included in the package: screws, bolts, nuts, washers, 3 pcs dura seal, and silicone pads. The 2,5 m cable ensures plenty of reach, and it's used with 9-36 V. It can be installed as is or with a license plate holder. (Part No. ST-809455).



Use the QR code to check out the product.

FOR9T ILLUSION

TAIL LIGHTS

HORIZONTAL
OR
VERTICAL



812.-

RECOMMENDED RETAIL PRICE
EXCL. VAT

✓ **EASY HORIZONTAL AND VERTICAL INSTALLATION**

Thanks to the square size and 115 mm CC, swapping out your old lights for these eye-catching FOR9T tail lights is a breeze. The FOR9T Illusion fits all IZE LED frames (Part No. ST-800635 - ST-40). These frames accommodate one to five Illusion lamps in either vertical or horizontal configurations. You can also install the Illusion using the IZE LED rubber housings (Part No. ST-800112 - ST-13). IZE LED frames make installation easier and can be painted to match your style. Achieving a perfect setup has never been simpler.

PART NO.	ST-800655	ST-800656	ST-800657	ST-800658
VOLTAGE	10-40V DC	10-40V DC	10-40V DC	10-40V DC
CONSUMPTION	15,5W	8,5W	6W	11W
CONSUMPTION FUNCTION	Tail: 4,5W, Brake: 5W, Indicator: 6W	Tail: 4W, Brake: 4,5W	Indicator: 6W	Reverse: 5W, Fog: 6W
FUNCTION	Tail, brake, indicator	Tail, brake	Indicator	Reverse, fog
IP-CLASS	IP67	IP67	IP67	IP67
COLOR LENS	Dark	Dark	Dark	Dark
CONNECTION	Cable	Cable	Cable	Cable
CABLE LENGTH	2500 mm	2500 mm	2500 mm	2500 mm
MATERIAL HOUSING	Polycarbonate	Polycarbonate	Polycarbonate	Polycarbonate
MATERIAL LENS	Polycarbonate	Polycarbonate	Polycarbonate	Polycarbonate
LENGTH	133 mm	133 mm	133 mm	133 mm
DEPTH	46 mm	46 mm	46 mm	46 mm
HEIGHT	110 mm	110 mm	110 mm	110 mm
CC	115 mm	115 mm	115 mm	115 mm
OPERATING TEMPERATURE	-30 ~ +65°C	-30 ~ +65°C	-30 ~ +65°C	-30 ~ +65°C
E-APPROVED	ECE R148	ECE R148	ECE R148	ECE R148
EMC-CERTIFICATE	ECE R10	ECE R10	ECE R10	ECE R10

Mounting details included: Screws, nuts, nylon washer

✓ **FOR9T: EVERYTHING YOU NEED**

The FOR9T series has taken us by storm with its unique position lights. Let us introduce the FOR9T Orbi and Illusion tail lights, which are a perfect match in quality, style, and functionality. The premium quality and eye-catching position lights complement all FOR9T products, including position, work, and driving lights. The different depths, layers, and functions of each light make them truly unique and attention-grabbing. The Orbi and Illusion tail lights are available in four options: tail/brake/indicator, reverse/fog, tail/brake, and indicator.

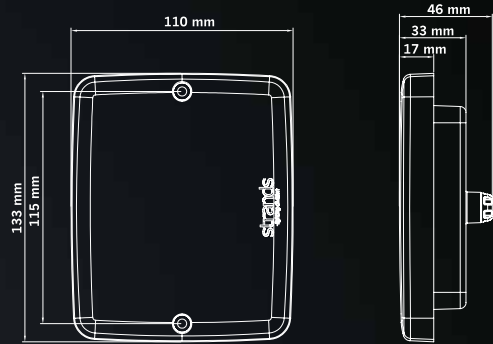

INDICATOR LIGHT

Part No. ST-800657

TAIL/BRAKE/INDICATOR, 3 FUNCTION LIGHT

Part No. ST-800655



TAIL/BRAKE LIGHT

Part No. ST-800656

FOG/REVERSE LIGHT

Part No. ST-800658

✓ **ALL TAIL LIGHT FUNCTIONS**

Thanks to the diverse range of FOR9T products, any driver can achieve a cohesive look from every angle. The Orbi and Illusion tail lights ensure you have all the necessary functions in various combinations: tail, brake, indicator, reverse, and fog light. All FOR9T tail lights are E-approved to suit any driver. They're designed to endure the challenges of the road and withstand dirt and water. Each function has a distinct look and placement within the lamp.

✓ **MODERN DESIGN**

Strands Lighting Division is dedicated to enhancing the daily driving experience with innovative, high-quality products. The FOR9T series combines functionality and technology with a modern design. These lights encompass all the features you need, featuring a position light design that offers a fresh, captivating look. Select from a diverse range of FOR9T products to achieve a cohesive style for any vehicle.



Use the QR code to check out the product.

FOR9T 9''

DRAGON DRIVE

- ✓ 9300 ACTUAL LUMENS
- ✓ E-MODE AND XPERIENCE MODE
- ✓ DUAL-COLOR POSITION LIGHT



- ✓ AMBER AND WHITE POSITION LIGHT

DRIVING LIGHT
Part No. ST-270969

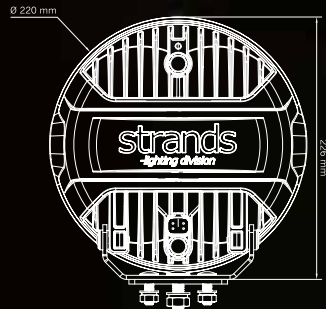

- ✓ CONSUMPTION
135W

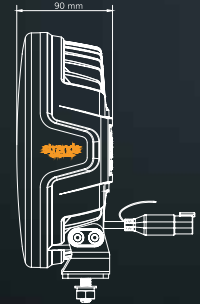
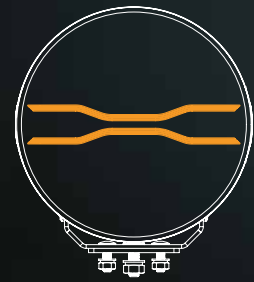

2434:-
RECOMMENDED RETAIL PRICE EXCL. VAT

- ✓ 1 LUX @
600 M

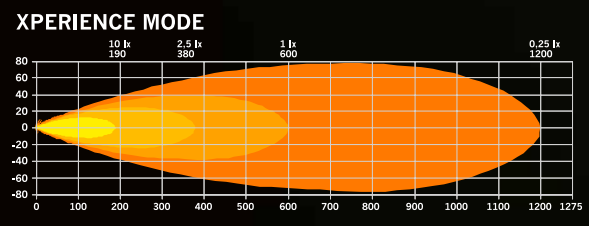
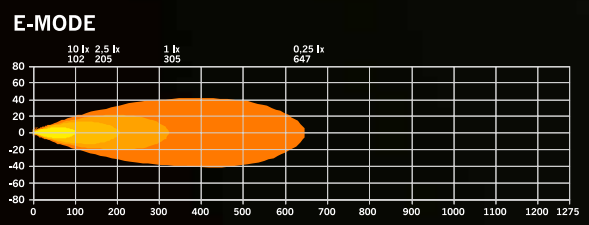

Use the QR code to check out the products.

FOR9T 7"

DRAGON DRIVE

- ✓ DUO COLOR POSITION LIGHT
- ✓ EASY TO MOUNT AND LOW WEIGHT
- ✓ 1 LUX @ 446 METER
- ✓ MORE THAN 6000 LUMEN



✓ 1 LUX @
446 M

✓ AMBER AND WHITE
POSITION LIGHT

DRIVING LIGHT
Part No. ST-270967

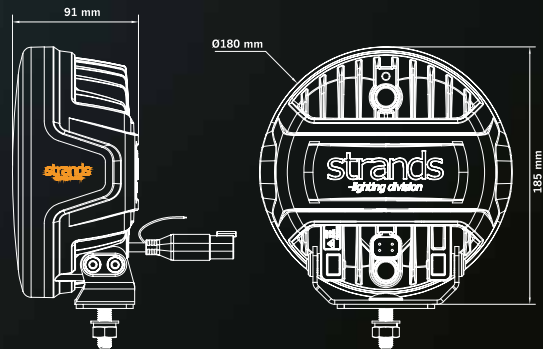

2190:-
RECOMMENDED RETAIL PRICE EXCL. VAT

✓ CONSUMPTION
105W

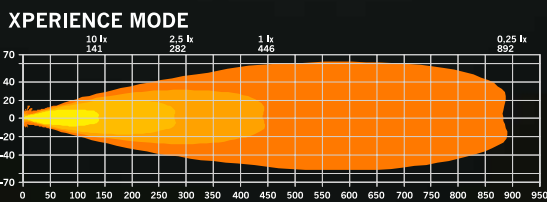
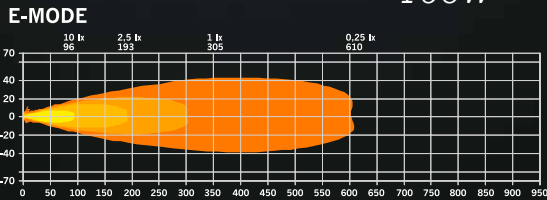

Use the QR code to
check out the product.

FOR9T NO-GLARE

WORK LIGHT



Use the QR code to check out the products.

- ✓ NO-GLARE FUNCTION
- ✓ SAFE AND COMFORTABLE WORK ENVIRONMENT
- ✓ DUAL-COLOR POSITION LIGHT
- ✓ 3220 LUMEN

Part No. ST-809260

78W

812:-

RECOMMENDED RETAIL PRICE EXCL. VAT

✓ **RED AND AMBER POSITION LIGHT**

✓ **VOLTAGE**
10-48V DC



31W

Part No. ST-809259

1215:-

RECOMMENDED RETAIL PRICE EXCL. VAT

NO-GLARE



AWIMEX
YOUR NEED - OUR SOLUTION

strands
-lighting division

FOR9T SCALE

- ✓ 90 MM CC
- ✓ EYE-CATCHING DETAILS
- ✓ 10-40 V DC COMPATIBLE



✓ **POSITION LIGHT**
6000K

REAR POSITION
Part No. ST-850453

✓ **SIDE MARKER**
1650K

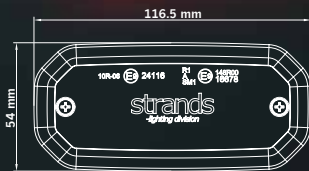

✓ **REAR POSITION LIGHT**

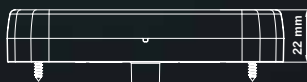

192:-

RECOMMENDED RETAIL PRICE EXCL. VAT



SIDE MARKER AMBER
Part No. ST-850452

POSITION LIGHT WHITE
Part No. ST-850451



Use the QR code to
check out the products.

✓ **FITS HANGING BRACKET**

Complete your setup with the hanging bracket for
side marker Part No. ST-850450, available separately.

AWIMEX
YOUR NEED - OUR SOLUTION

strands
-lighting division

NUUK E-LINE SCENE LIGHT

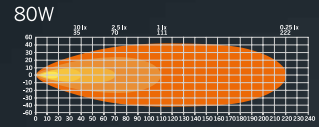
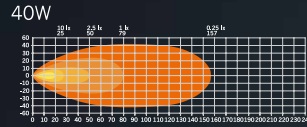

1299:-
RECOMMENDED RETAIL PRICE EXCL. VAT

- ✓ MORE THAN 8200 ACTUAL LUMENS
- ✓ REIMAGINED ILLUMINATION
- ✓ A WORK LIGHT WITH PERFECT PRECISION
- ✓ EASY TO INSTALL



Use the QR code to check out the products.

Part No. ST-809136

Voltage	9-36V DC
Consumption	80W, 40W
Theoretical lumen	9200 lm
Actual lumen	8200 lm / 4100 lm
1 lux @	111 m / 79 m
Color temperature	5000K
Beam pattern	Wide beam
IP-class	IP68/IP69K
Connection	Cable
Cable length	2500 mm

Material housing	Aluminium
Material lens	Polycarbonate
Length	566 mm
Depth	52,8 mm
Height	43,9 mm
Height including bracket	43,9 mm
Angle	58°
Operating temperature	-40°C - +60°C
E-approved	No
EMC-certificate	ECE R10

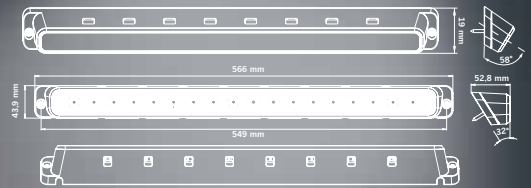

NUUK E-LINE WORK LIGHT

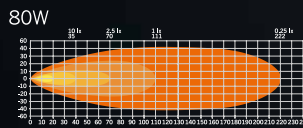
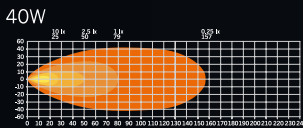

- ✓ 8200 ACTUAL LUMENS
- ✓ SLIM AND LIGHTWEIGHT
- ✓ REIMAGINED WORK LIGHT

1219:-
RECOMMENDED RETAIL PRICE EXCL. VAT



Use the QR code to check out the product.

Part No. ST-809137

Voltage	9-36V DC
Consumption	80W, 40W
Theoretical lumen	9200 lm
Actual lumen	8200 lm / 4100 lm
1 lux @	79 m / 111 m
Color temperature	IP68/IP69K
Beam pattern	5000K
IP-class	Wide beam
Connection	Cable
Cable length	2500 mm

Material housing	Aluminium
Material lens	Polycarbonate
Length	514 mm
Depth	28,2 mm
Height	30 mm
Height including bracket	39,5 mm
Operating temperature	-40°C - +60°C
E-approved	No
EMC-certificate	ECE R10

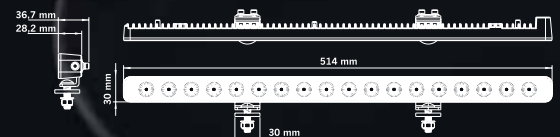

DARK KNIGHT STROBE LIGHT DUO



Use the QR code to check out the products.



✓ THREE E-APPROVED OPTIONS

Choose between a single (6 LEDs), double (12 LEDs), or a triple row (18 LEDs) light. The optics are designed to emit the most powerful and efficient light output, giving you an intense and precise beam.

✓ DUO COLOR AND SUPER-DARK LENS

The Dark Knight strobe light has two flashlight options: amber and white. While the flashes are incredibly strong, the super-dark lens gives it a smooth and stylish look when not in use.

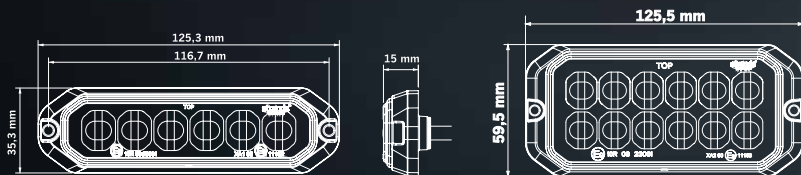

Part No. ST-850460

509:-

RECOMMENDED RETAIL PRICE EXCL. VAT



Part No. ST-850461

609:-

RECOMMENDED RETAIL PRICE EXCL. VAT



Part No. ST-850462

710:-

RECOMMENDED RETAIL PRICE EXCL. VAT

✓ POWERFUL LIGHT

This powerful light provides high visibility with low power consumption, consuming only 12-26 W. It can be installed on a wide range of vehicles thanks to the 10-32 V DC compatibility. With 20 warning light patterns, including steady on, you can find the perfect one for any situation.

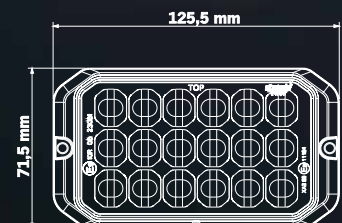

Part No. ST-850460, ST-850461, ST-850462

Voltage	10-32V DC	Cable length	1000 mm
Consumption	Amber: 13W/25W/26W White: 12W/24W/24W	Material housing	Aluminium
Color temperature	Amber: 1700K, White: 6000K	Material lens	Polycarbonate
Functions	Warning light	Length	125.3 mm / 125.5 mm / 125.5 mm
Patterns	20	Depth	15 mm
IP-class	IP67/IP69K	Height	35.3 mm / 59.5 mm / 71.5 mm
Color lens	Dark	CC	116.6 mm / 117.2 mm / 117.2 mm
Color LED	White and amber	Operating temperature	-40°C - +60°C
Connection	Cable	E-approved	ECE R65 Class 1 / Class 2 / Class 2
		EMC-certificate	ECE R10



ADDRESS

Fabriksgatan 27
272 36 Simrishamn

CONTACT US

Phone: 0414-160 50
E-mail: info@awimex.se



YOUTUBE. *Subscribe at Strands Lighting Division for innovative lighting in action and get detailed information about our products.*



LINKEDIN. *Follow us at Strands Group AB for industry insights, news, and exciting updates.*



WEBSITE. *Visit www.strandseurope.com for detailed information about our products.*



INSTAGRAM. *Follow us at @strandslightingdivision for inspiration, exciting news, and participate in competitions.*



FACEBOOK. *Like Strands Lighting Division, engage in discussions and be the first to know about product news.*

