



FIN6 POWER

Lithium battery warning light

Features

- > Three-in-one warning light, floodlight, and power bank
- > Bluetooth compatible; controllable via app with the smartphone
- > Led colors: Warning light: Amber/Red/Blue/Red Blue split color; Flood light: White
- > 5-year warranty, 1-year warranty for battery
- > Three 1/4 " nut give possibilities to various bracket options to meet different scenarios
- > Waterproof USB Type-C interface during charging and discharging

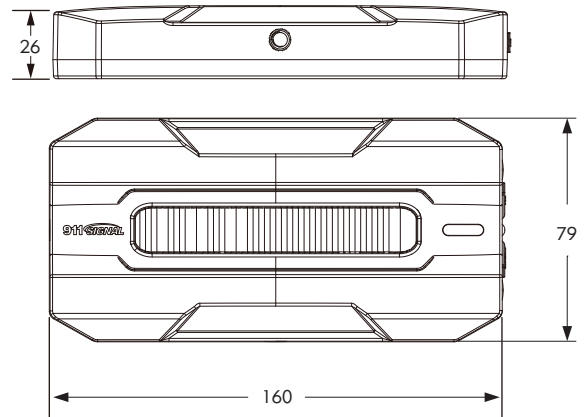

| Item | Warning Light | Flood Light | Lithium Battery | Max Power | LED | Flash Patterns | Operating Temperature | Certification | Output | Flood Light Lumen | 5V, 2.1A Charging Time | Warning Light Working Hours |
|----------|---------------|-------------|------------------|-----------|--|----------------|-----------------------|---|----------|-------------------|------------------------|--|
| 022717R | ● | ○ | 3.7 V 10000mA | 9W | Flood Light: 6pcs 2W Warning Light: 6pcs 3W | 9 | 0 to 50°C | SAE J595 CA T13 ECE R65 ECE R10 UN 38.3 | 5V, 2.1A | 600 | 5H | Intensity50%: 12H Intensity100%: 6H |
| 022717B | ● | ○ | | | | | | | | | | |
| 022717A | ● | ○ | | | | | | | | | | |
| 022717RB | ● | ○ | | | | | | | | | | |









911 Signal Technology Inc.

Tel: +86 574 89017911 - 8001 Fax: +86 574 82822560

Email: sales@911signal.com

www.911signal.com



| Item | Accessories | Picture | Specification | Application |
|--------|---------------------------------|---|---|--|
| 103204 | Single Suction cup bracket |  | 1/4" Ball End / 9cm metal rod / Vacuum single suction cup | Surface installation of non-ferrous vehicles or transportation facilities (Installation outside the car is not suitable for driving) |
| 103205 | Triple suction cup bracket |  | 1/4" Ball End / 9cm metal rod / Three vacuum suction cups | Surface installation of non-ferrous vehicles or transportation facilities (Suitable for installation outside the car, the installation surface must be clean) |
| 105801 | PTZ adjustable magnetic bracket |  | 1/4" Ball End with PTZ / 66MM DIA suction 20Kg magnet suction cup | Surface installation of iron vehicles or transportation facilities (For example, road guardrail or ground placement use) |
| 105901 | Rearview mirror rod bracket |  | 1/4" Ball End / 9cm metal rod / Round rearview mirror rod fixing base (Including straight wrench, four kinds of adaptable gaskets) | 9-15mm diameter round tube (such as motorcycle rearview mirror) |
| 105902 | Rearview mirror base bracket |  | 1/4" Ball End / 9cm metal rod / Rearview mirror fixing base | Round tube of diameter less than 28mm (such as motorcycle rearview mirror) |
| 106001 | Handlebar base bracket |  | 1/4" Ball End / 9cm metal rod/Handlebar fixing base (Including straight wrench, protective rubber pad and two kinds of U-shaped stainless steel) | 13-33mm diameter round tube (such as motorcycle handle) |
| 106101 | Double thread bracket |  | Two 1/4" Ball End / 9cm metal rod / Magnet suction cup with a diameter of 88MM and a suction force of 40Kg | Surface installation of non-ferrous vehicles or transportation facilities |
| 106201 | Cone barrel iron bracket |  | Inner diameter 64 MM iron material | Installed on the road cone |

